

EMA11

ELECTRICAL MULTIFUNCTION ANALYZER

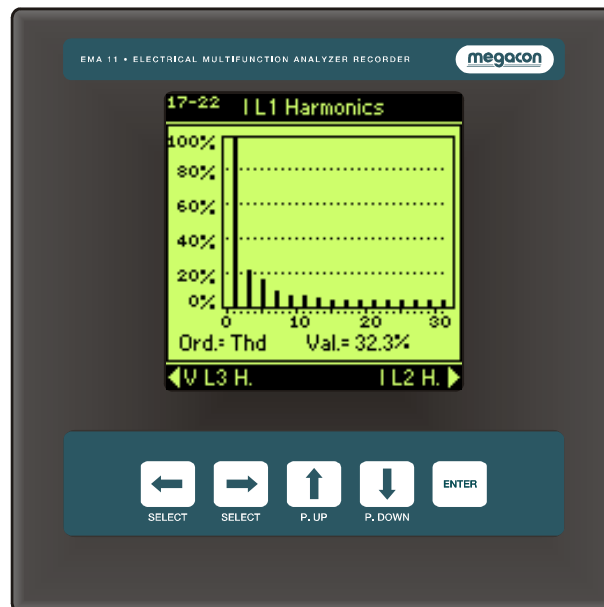

User Manual

IM 135-U-M v. 4.0

EMA11 IM135-U-M v4.0.doc

EMA11 - USER MANUAL

Information in this document is subject to change without notice and does not represent a commitment on the part of Megacon.

This documentation is consigned to the customer to enable the correct and safe operation of the instrument; any other use of documentation is strictly prohibited.

The information contained herein is the property of Megacon, and by law, no part of it may be reproduced, transcribed, stored in any retrieval system, or translated into any language by means (even for internal purposes by the customer) without the express written permission of Megacon.

In addition, no part of this manual may be transmitted in any form by any means, including photocopying and recording, for any purposes, without the express written permission of Megacon.

In case of Copyright violation the customer is directly responsible.

TERMS OF WARRANTY

The warranty is valid for the period of twelve months after material receipt.

The warranty covers free repair or replacement of equipment parts, which are recognized as faulty due to manufacturing defects.

Warranty does not cover those parts which results defective due to misuse or improper use, incorrect installation or maintenance, operation by unauthorized personnel, damage during transportation, or which in any case do not show manufacturing defects of the equipment.

Not included in the warranty terms are technical interventions regarding equipment installation to electrical systems.

The manufacturer declines any responsibility for eventual injury or damage to persons, animals or things as result of failure to follow the instructions in the user manual or caused by improper use of equipment.

The expenses of transport as well as the relative risks of same both to and from the place of repair, will be the sole responsibility of the user.

This warranty expires after the date of purchase and any assistance required after said date including spare parts, labour, transport of personnel and material will be charged to the user following the tariffs in force for Technical Assistance Service at the time of such requested service.

In any case the replacement of the equipment as well as the extension of warranty after such breakdown is excluded.

INDEX

1)	MAIN INFORMATION _____	5
1.1)	INTRODUCTION _____	5
1.2)	DESCRIPTION _____	5
1.3)	CE CONFORMITY AND STANDARDS _____	5
2)	TECHNICAL FEATURES _____	6
2.1)	GENERAL SPECIFICATIONS _____	6
2.2)	MEASURING METHOD AND ACCURACY _____	8
2.3)	PROGRAMMABLE PARAMETERS (SETUP SECTION) _____	8
2.4)	MEASURED VARIABLES _____	9
2.5)	CALCULATED VARIABLES _____	9
2.6)	MEASURING & CALCULATION FORMULAS _____	10
3)	INSTRUMENT DESCRIPTION _____	12
4)	INSTALLATION _____	13
4.1)	SAFETY _____	13
4.2)	OPERATOR SAFETY _____	13
4.3)	MOUNTING _____	14
5)	INTERNAL BATTERY _____	15
5.1)	REPLACEMENT INTERNAL BATTERY _____	15
6)	CONNECTION _____	16
6.1)	POWER SUPPLY _____	16
6.2)	VOLTAGE INPUTS _____	17
6.3)	CURRENT INPUTS _____	17
6.4)	WIRING DIAGRAMS _____	17
7)	PLUG-IN MODULE INSERTION _____	19
7.1)	INSERTION PROCEDURE _____	20
7.2)	DISCONNECTION PROCEDURE _____	20
8)	INPUT/ OUTPUT DEVICES _____	21
8.1)	STANDARD DIGITAL INPUTS _____	21
8.2)	STANDARD DIGITAL OUTPUTS _____	22
8.3)	INPUT / OUTPUT OPTIONS (“PLUG IN” MODULE) _____	23
8.3.1)	6 DIGITAL INPUTS OPTION 6DI (“PLUG IN”) _____	23
8.3.2)	2 DIGITAL INPUTS + 2 DIGITAL OUTPUTS OPTION 2DI+2DO (“PLUG IN”) _____	23

8.3.3)	4 STATIC DIGITAL OUTPUTS OPTION 4DO (“PLUG IN”)	24
8.3.4)	4 RELAY DIGITAL OUTPUTS OPTION 4DO (“PLUG IN”)	24
8.3.5)	2 ANALOG OUTPUTS OPTION 2AO (“PLUG IN”)	24
8.3.6)	4 ANALOG OUTPUTS OPTION 4AO (“PLUG IN”)	25
8.4)	SERIAL OUTPUTS	26
8.4.1)	RS485 CONNECTION NOT SHIELDED	26
8.4.2)	RS485 CONNECTION SHIELDED	27
8.4.3)	RS232 CONNECTION	27
8.4.4)	MODEM CONNECTION	28
8.4.5)	OPTION RS485/RS232 COM2 (“PLUG-IN”)	29
9)	USE	30
9.1)	FUNCTION KEYS	30
10)	REAL TIME VALUES	30
10.1)	VISUALIZATION TREE	31
10.2)	MEASURES VISUALIZATION	32
10.3)	STATUS AND INFORMATION PAGES	39
11)	SETUP	41
11.1)	SETUP ITEMS	41
11.2)	MAIN MENU SETUP	42
11.3)	GENERAL	43
11.4)	SERIAL COMM	44
11.5)	AVERAGE	44
11.6)	ENERGY	45
11.7)	STORAGE	47
11.8)	DIGITAL OUTPUT	48
11.9)	DIGITAL INPUT	49
11.10)	ANALOG OUTPUT (OPTION)	51
11.11)	RESET	52
11.12)	EXIT SETUP	52
12)	LIST OF MEASURES	52
13)	PROBLEMS AND SOLUTIONS	54
14)	EMA SERIAL COMMUNICATION PROTOCOL	55
15)	Notes	55

1) MAIN INFORMATION

1.1) INTRODUCTION

EMA11 was engineered and tested in compliance with IEC 348 class 1 standards for operating voltages up to 600 Vac rms, considering the VDE 0110 group C isolation standards for operating voltages up to 500 Vac rms.

The present manual contains all of the information warnings that must be followed up by the operator to ensure a right use of the equipment and to maintain the safe operating conditions.

1.2) DESCRIPTION

The EMA11 is an instrument which has been designed to monitor, store and analyze all electrical variable in a distribution line.

All the relevant data are displayed and, if desired, stored on internal RAM and transmitted to a remote PC, via RS485 (standard) on which the compatible management software has been installed.

It is possible to monitor via digital outputs (2 dig. out. standard) alarms, sirens or strategically factory loads.

EMA11 with optional harmonic analyzes can carry out network harmonic content analyzes with FFT method up to the 31st harmonic, very useful to locate network disturbances.

The EMA can perform accurate deep and complete energy analyzes.

A fundamental feature of EMA11 is the easy way to integrate new additional options and the upgrading of the firmware using serial port and flash technology.

All parameters are displayed on a graphic LCD display light-back with a resolution of 128x128 dots.

Displaying and programming mode are carried out by means of a 5 buttons keyboard.

1.3) CE CONFORMITY AND STANDARDS

The instrument was tested in compliance with EMC 89/336/EEC and complies with the following standards:

EMISSIONS = EN 50081-2, 1992 - EN 55022-CLASS B CISPR 22

IMMUNITY = EN 50082-1, 1992 - EN 61000-6-2

SAFETY = EN 61010-1

2) TECHNICAL FEATURES

2.1) GENERAL SPECIFICATIONS

Power supply/Auxiliary voltage

85-265 V 50/60 Hz/dc.

20-60 V 50/60 Hz/dc (option).

Isolation voltage

3700 Vac rms x 1 minute.

Voltage input

3 inputs, range 10-600Vrms between phase-phase.

Over voltage up to 750 Vac permanent, beyond this value it is imperative to use voltage transformers.

Over voltage category: III (fixed installation)

Pollution degree: 2 (normally not conductive; temporary conductive for condensation)

Resistor input: >2 MΩ.

Burden 0.2 VA.

Current input

	Model EMA11	Model EMA11-1A
3 isolated inputs (internal CT) range	10mA-5A rms	4mA-1A rms
Over current max	10A (100A for 1 second)	2A (10A for 1 second)
Burden	0.2 VA	0.04 VA

Consumption

4VA typical.

6VA max, full optional.

Serial output

RS485/RS232 (configurable on board), half duplex isolated, signals Tx/Rx, Gnd.

Programmable baud rate from 1.200 to 19.200 bps.

Communication protocol: standard ASCII and MODBUS-RTU.

Input signals

2 passive opt isolated inputs (1000 V), 12 - 24 Vdc (up to 8, using options).

Output signals

2 photomos outputs, 12-230 Vac-dc / 150mA max (up to 6, using options).

2, 0-20 or 4-20 mA analog outputs, galvanic insulation (option).

Memory data retention

RAM: 128 KB (useful 80KB); 1 Mbytes (all useful) option.

No volatile memory data using internal battery.

Data retention: 5 years (typical) at +25°C (77°F).

Stored variables: Average power, Min/max values, Harmonics (option), Samples.

Display interface

128x128 dot graphic LCD at high contrast (adjustable) and with LED backlit. Dimension 70x70mm.

Keyboard interface

5 functional keys for paging and programming.

Operating temperature

From -10°C (14°F) to +50°C (122°F).

Storage temperature

From -15°C (5°F) to +70°C (158°F).

Operating humidity

90% not condensing.

Protection standards

IP 52 front (EN60529) - IP65 with gasket (on request).

IP 20 screw and terminals.

Weight and dimension

0,430 kg app. (equipped with 2 digital outputs, 2 digital inputs, RS485 and RS232, Memory 128Kbytes), 144x144x66 mm.

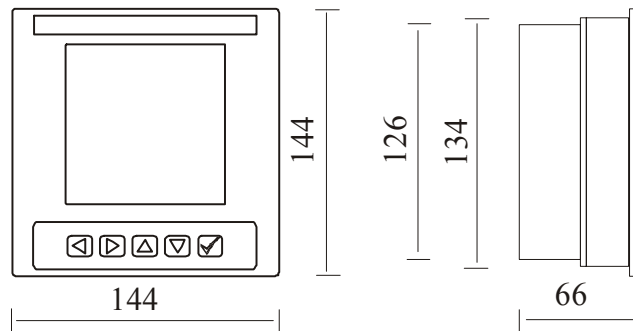

2.2) MEASURING METHOD AND ACCURACY

Measuring range

30-500Hz.

Measuring method

64 sampling per period for V1 and I1, V2 and I2, V3 and I3.
Measuring interval 0,1 second.

Instrument accuracy

	Model EMA11	Model EMA11-05
Voltage	< 0.5 %	< 0.25 %
Current	< 0.5 %	< 0.25 %
Power	< 1 %	< 0.5 %
Energy	< 1 %	< 0.5 %
Power Factor	< 1 %	< 0.5 %
Standard	EN 61036	EN60687

Sampling frequency

45 Hz=2.280 or at 60 Hz = 3,88kHz

Zero self-regulation

Offset

0,1 second.

RTC - REAL TIME CLOCK

Accuracy: 5 PPM, standard CEI-EN 61038

2.3) PROGRAMMABLE PARAMETERS (SETUP SECTION)

VT and CT ratio.

Mode, insertion type (4 wires, 3 wires, Aron).

Integration time of Average parameters.

Sampling frequency.

Address or logical number of equipment.

Date and time.

Time-bands of power consumption in different periods.

Storage section (Min/max, Harmonics, average power and Sampling values).

All parameters concerning the input/output section (serial port, analog output, digital input and output).

Preset energy counters.

2.4) MEASURED VARIABLES

PHASE VOLTAGE (Rms)
 LINE CURRENT (Rms)
 FREQUENCY
 TEMPERATURE

$V_{L1-N} - V_{L2-N} - V_{L3-N}$
 $I_{L1} - I_{L2} - I_{L3}$
 F_{L1} (Hz)
 $T(^{\circ}C)$

2.5) CALCULATED VARIABLES

LINE VOLTAGE (Rms)
 THREE-PHASE SYSTEM VOLTAGE (Rms)

$V_{L1-L2} - V_{L2-L3} - V_{L3-L1}$
 V

THREE-PHASE SYSTEM CURRENT (Rms)
 AVERAGE THREE-PHASE SYSTEM CURRENT
 MAXIMUM AVERAGE THREE-PHASE SYSTEM CURRENT
 AVERAGE LINE CURRENT
 MAXIMUM AVERAGE LINE CURRENT
 NEUTRAL CURRENT
 AVERAGE NEUTRAL CURRENT
 MAXIMUM AVERAGE NEUTRAL CURRENT

I
 I_{avg}
 I_{maxavg}
 $I_{L1avg} - I_{L2avg} - I_{L3avg}$
 $I_{L1maxavg} - I_{L2maxavg} - I_{L3maxavg}$
 I_N
 I_{Navg}
 $I_{Nmaxavg}$

POWER FACTOR
 THREE-PHASE SYSTEM POWER FACTOR

$PF_{L1} - PF_{L2} - PF_{L3}$
 PF

$COS\phi$
 THREE-PHASE SYSTEM $COS\phi$

$COS\phi_{L1}, COS\phi_{L2}, COS\phi_{L3}$
 $COS\phi$

APPARENT POWER
 THREE-PHASE SYSTEM APPARENT POWER
 ACTIVE POWER
 THREE-PHASE SYSTEM ACTIVE POWER
 REACTIVE POWER
 THREE-PHASE SYSTEM REACTIVE POWER
 AVERAGE ACTIVE POWER
 AVERAGE REACTIVE POWER

$S_{L1} - S_{L2} - S_{L3}$ (VA)
 S (VA)
 $P_{L1} - P_{L2} - P_{L3}$ (W)
 P (W)
 $Q_{L1} - Q_{L2} - Q_{L3}$ (VAr)
 Q (VAr)
 P_{AVG} (W)
 Q_{AVG} (VAr)

THREE-PHASE SYSTEM ACTIVE ENERGY
 THREE-PHASE SYSTEM TRANSFERRED ACTIVE ENERGY
 THREE-PHASE SYSTEM INDUCTIVE REACTIVE ENERGY
 THREE-PHASE SYSTEM CAPACITIVE REACTIVE ENERGY
 Total counters and time bands are available.

$Wh+$
 $Wh-$
 $VArh+$
 $VArh-$

TOTAL HARMONIC DISTORTION - THD (%) CURRENT AND VOLTAGE
 HARMONIC ANALYZES (Option)
 Analyzes up to the 31st harmonic of both voltage and current for each phase.
 $V_{L1-N}, V_{L2-N}, V_{L3-N}; I_{L1}, I_{L2}, I_{L3}$ (%)

2.6) MEASURING & CALCULATION FORMULAS

Phase Voltage RMS $V_{LiN} = \sqrt{\frac{\sum_{k=1}^P v_{LiN}^2}{P}}$

Line Current RMS $I_{Li} = \sqrt{\frac{\sum_{k=1}^P i_{LiN}^2}{P}}$

Active Power $W_{Li} = \frac{\sum_{k=1}^P v_{LiN} \cdot i_{LiN}}{P}$

Reactive Power $Q_{Li} = \frac{\sum_{k=1}^P v_{LiN} \cdot i_{LiN}(k-\Delta)}{P}$

Apparent Power $A_{Li} = V_{LiN} \cdot I_{LiN}$

Cos $\varphi_{Li} = \frac{W_{Li}}{\sqrt{W_{Li}^2 + Q_{Li}^2}}$

Power Factor $PF_{Li} = \frac{W_{Li}}{A_{Li}}$

Active Energy $Wh_{Li} = \int_0^{\infty} W_{Li} dt$

Reactive Energy	$Qh_{Li} = \int_0^{\infty} Q_{Li} dt$
Line Voltage	$V_{Lij} = \sqrt{\frac{\sum_{k=1}^P v_{Lij}^2}{P}}$
3 - Phase Line Voltage	$V_{3\Phi} = \frac{V_{L12} + V_{L23} + V_{L32}}{3}$
3 - Phase System Current	$I_{3\Phi} = \frac{I_{L1} + I_{L2} + I_{L3}}{3}$
3 - Phase Active Power	$W_{3\Phi} = W_{L1} + W_{L2} + W_{L3}$
3 - Phase Reactive Power	$Q_{3\Phi} = Q_{L1} + Q_{L2} + Q_{L3}$
3 - Phase Apparent	$A_{3\Phi} = A_{L1} + A_{L2} + A_{L3}$
Active Energy	$Wh_{3\Phi} = \int_0^{\infty} Wh_{3\Phi} dt$
Reactive Energy	$Qh_{3\Phi} = \int_0^{\infty} Qh_{3\Phi} dt$

Harmonic analyzes:
Cooley - Tukey algorithm.

$$H(k) = \sum_{n=0}^{N-1} h(n) \cos\left(\frac{2\pi nk}{N}\right) - j \sum_{n=0}^{N-1} h(n) \sin\left(\frac{2\pi nk}{N}\right)$$

for $0 \leq k \leq N - 1$ $N = 64$

3) INSTRUMENT DESCRIPTION

The front panel of the EMA11 is described on the following section:

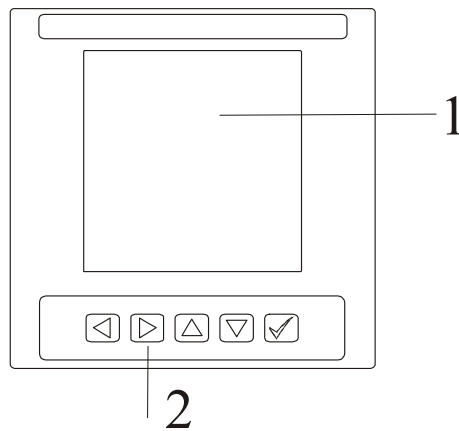

1 DISPLAY

Back lighted graphic LCD 70x70mm, 128x128 dot, dot pitch 0.35mm x 0.35mm, dot size 0.32mmx0.32mm, high viewing direction 60°, positive and negative visualization at low reflection.

2 KEYBOARD

In the "Acquisition Mode" the "up" and "down" arrows allows to skip through the measuring page of the instrument while in the "Setup Mode" all the buttons including "Enter" key allows to program the instrument.

4) INSTALLATION

4.1) SAFETY

On receipt of the instrument and prior to installation, make sure it is intact and has not been damaged during shipment.

Before installing, make sure the operating voltage and mains voltage are compatible.

The instrument power supply must not be earthed.

The instrument is equipped with a fuse on the power supply type: 5x20mm 315mA 250V Fast (i.e. Schurter FSF).

- Always disconnect the instrument from all power sources before opening it for maintenance and/or repairs.
- The instrument's capacitor may still be charged even after it has been disconnected from all power sources.
- Maintenance and/or repairs must only be carried out by qualified and authorized personnel.
- If in any doubt about the instrument's safety take it out of service and implement the necessary procedures to prevent its inadvertent use.
- Instrument operation is no longer safe:
 - A) when the instrument shows clear signs of damage.
 - B) when the instrument does not work.
 - C) after long storage in extreme conditions.
 - D) after serious damage during shipment.

4.2) OPERATOR SAFETY

Carefully read the following pages before installing and using the purchased instrument.

Maintenance and/or repairs must only be carried out by qualified and authorized personnel.

To ensure proper and safe use of the instrument and its correct maintenance and/or repairs, authorized personnel must follow normal safety procedures at all times.

SYMBOLS



READ CAREFULLY THE CONTAINED INSTRUCTIONS

4.3) MOUNTING

The unit needs to be installed on front panel of mains control/switchboards, wiring and connections must be carried out following the EMC (Electro-Magnetic-Compatibility) procedures. Plug in screw terminal blocks are used for appropriate wiring. There is a security locking on the current inputs terminal block.

Suggested is to install the equipment on vibration free switchboards and with an environmental temperature ranging between -10 °C and +50°C.

The panel cut-out of the unit is the following:

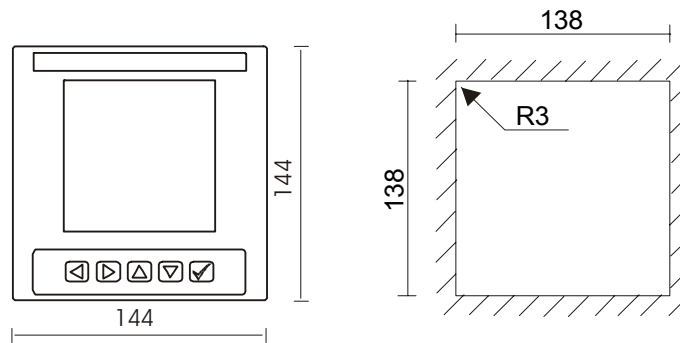

Following the picture below mentioned, insert the instrument from the front side of the switchboard; from behind insert black support guide on the screw of the instrument, once the black support guide fits on the screw and is pushed against the instrument and the internal panel, screw the nut until the instrument is fixed on the panel.

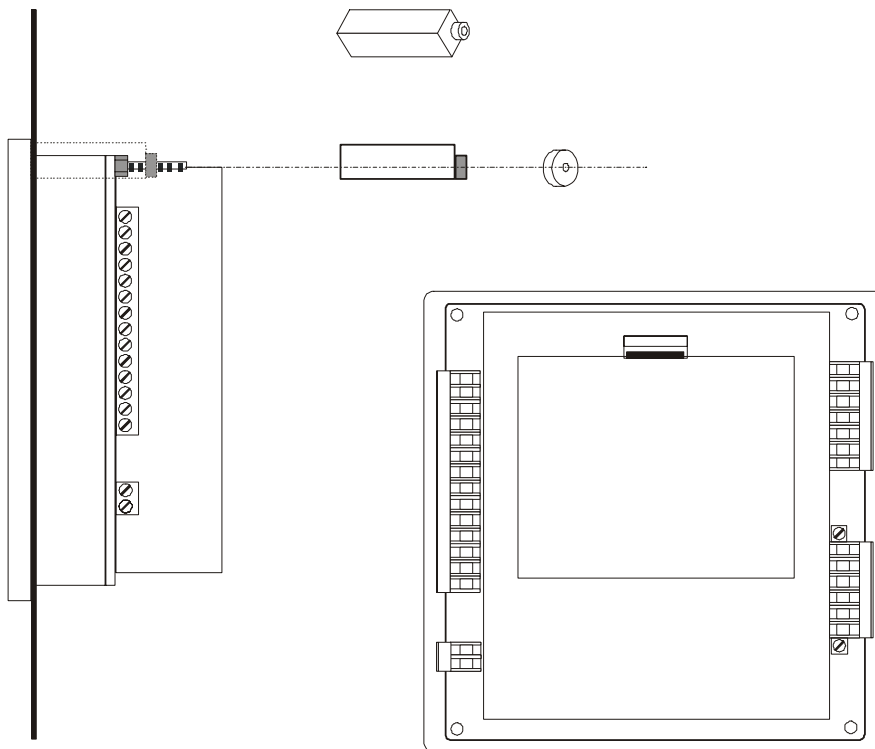

There are n.4 support guides and n.4 nuts to mount the instrument.

5) INTERNAL BATTERY

To avoid to lose the setup and all storing data, the instrument is equipped of an internal battery (CR2450).

5.1) REPLACEMENT INTERNAL BATTERY

Only a qualified and authorized technical person can change the internal battery.

This operation will delete all storing data and it will restore the default setup with the exception of the password and the code to enable the harmonics and time bands. Using the software NRG (or relative serial commands) it's possible to download all storing data to avoid to losing same.

The next figure shows where is located the battery inside the instrument.

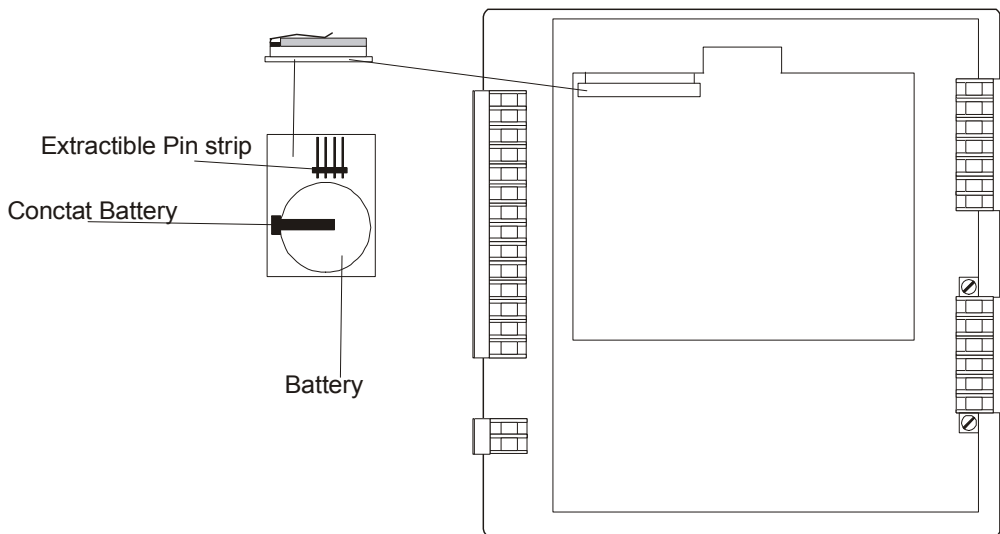

Instruction to change the internal battery:

- 1) It's necessary to cut off the power supply of instrument and to disconnect all inputs and all outputs.
- 2) Remove the seal from the rear door.
- 3) Open and remove the rear door.
- 4) It's necessary to pay attention to presence of residual voltage inside the instrument. Extract the battery circuit without touching any other component.
- 5) Change the battery. Put the positive pole in the upper direction.
- 6) Plug in the circuit with the new battery (in the upper directions) inside the instrument. The 4 pin strip must meet with their relative support.
- 7) Mount the rear door again and close it. Restore all the connection and turn on the instrument.
- 8) In the Warnings page is possible to check the condition of battery (BATTERY OK).

6) CONNECTION

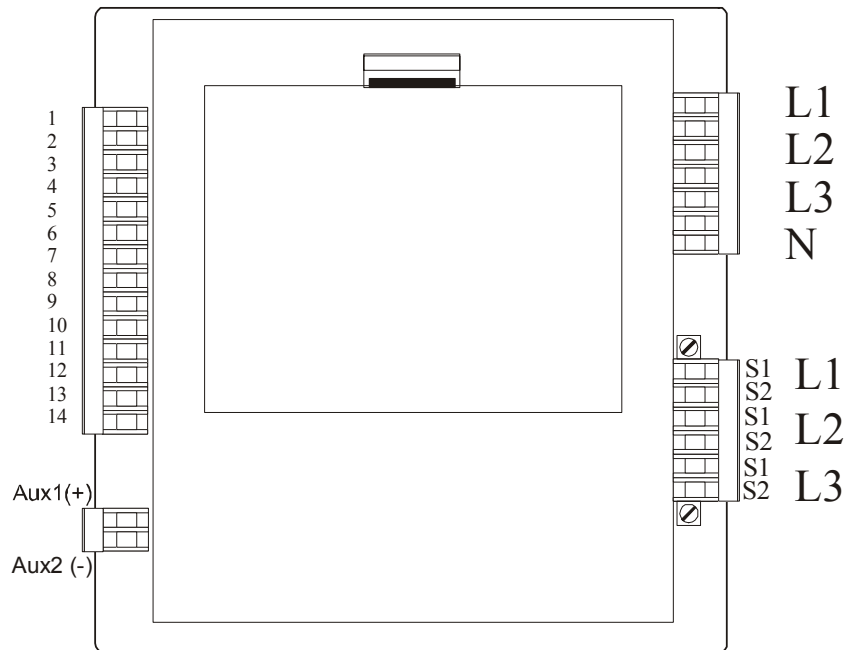

Connection Table

Connector	Name	Connector	Name
1	TX/A (ser.output)	8	2 Digital Input (+)
2	RX/B (ser.output)	9	2 Digital Input (-)
3	COM (ser.output)	10	
4		11	1 Digital Output (+)
5		12	1 Digital Output (-)
6	1 Digital Input (+)	13	2 Digital Output (+)
7	1 Digital Input (-)	14	2 Digital Output (-)

6.1) POWER SUPPLY

The instrument doesn't work without power supply.



Before powering the instrument verify always to insert the right value (85-265 Vac/dc standard; 20-60 Vac/dc OPTION).

The instrument is equipped with an internal protection fuse on the power supply, type 5x20mm dimensions, 315mA 250V, Fast (i.e. Schurter FSF). If the instrument is off, with presence of power supply, it's necessary to verify the internal fuse.

In case of fuse replacement, disconnect the instrument from the power supply, current plus voltage input and all input/output sections (digital input/output, analog output, RS485/RS232 serial port etc.), then open the rear door and change the fuse that is near the power supply connector (in the low part of instrument). Only a qualified and authorized technical person can change the fuse. Extract the interrupted fuse using a screwdriver and with a plier insert the new fuse.

The instrument's power supply does not require any earth connection.

6.2) VOLTAGE INPUTS



EMA11 can measure voltages up to a maximum 600 Vrms between phase-phase, further that value it is imperative to use voltage transformer. When using voltage transformer, make sure to respect the input and output polarities.

Use cables with maximum cross-section of 2.5mm² attach them to the voltage measurement screw terminals.

Connect the instrument following up the wiring diagrams described on chapter **Errore. L'origine riferimento non è stata trovata.**

EMA11 was developed and tested in accordance with IEC 348 class 1 standards for operating voltages up to 600 Vac rms.

6.3) CURRENT INPUTS

Connect the instrument following up the wiring diagrams described on chapter **Errore. L'origine riferimento non è stata trovata.**



WARNING: before connecting the current inputs to the terminals of the instrument are advised that the maximum allowable current input must be and not exceed 5A.



WARNING: to prevent accidentally disconnection of the current input, EMA11 is equipped with screw able current input, in order to avoid negligence, operator must first shutdown the system and short circuit the secondary wiring of the current transformer, if used, and unscrews the current input terminals.

6.4) WIRING DIAGRAMS

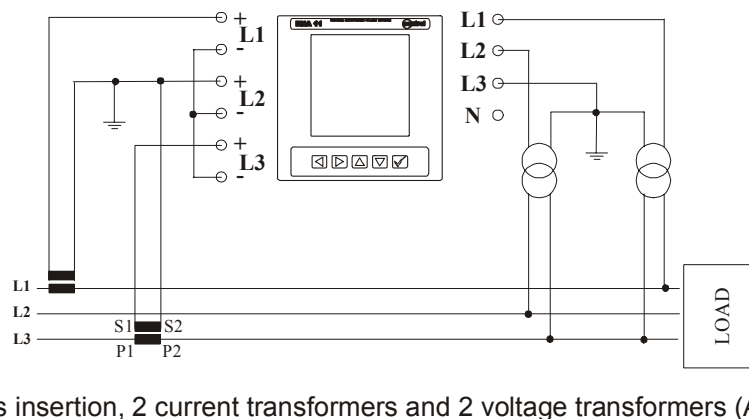
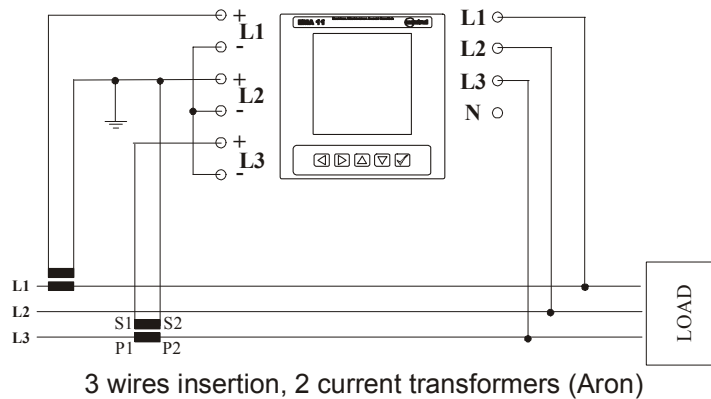

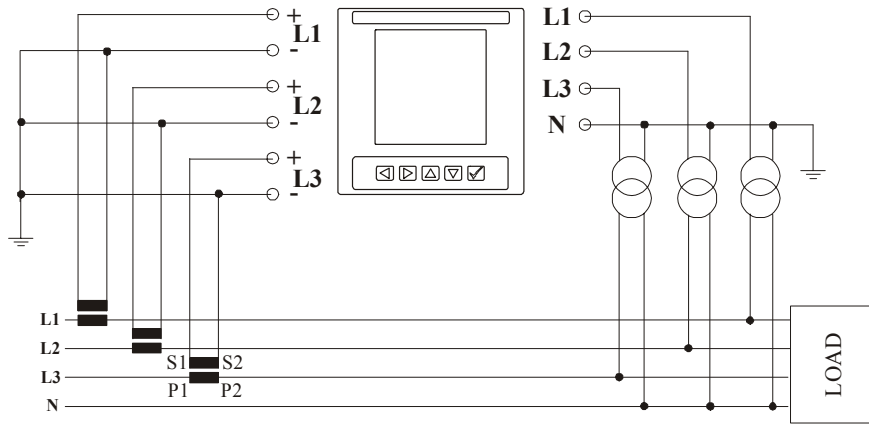

4 wires insertion, 3 current transformers and 3 voltage transformers

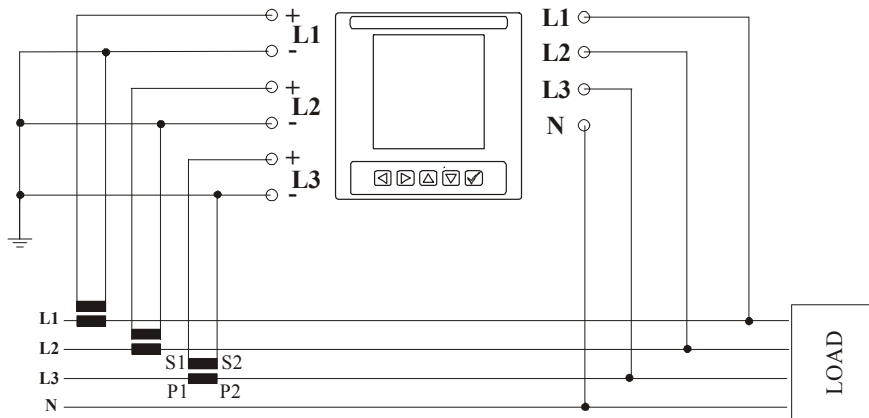

4 wires insertion, 3 current transformers

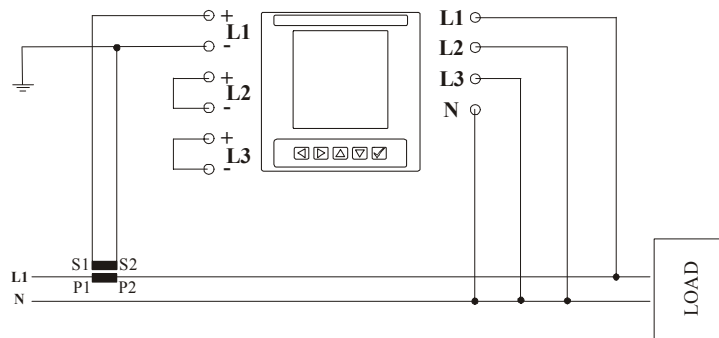

Single phase insertion, 1 current transformer

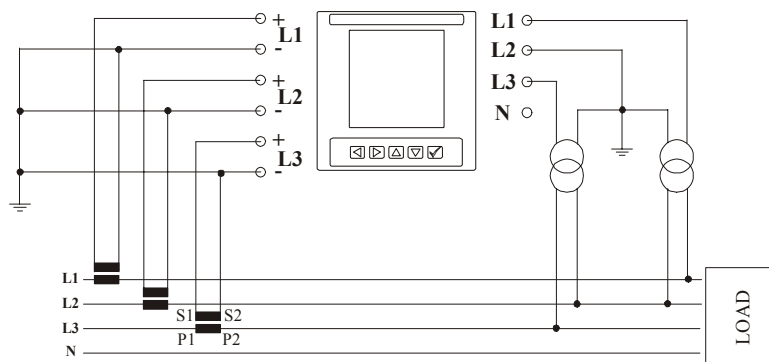

4 wires insertion, 3 current transformers and 2 voltage transformers

7) PLUG-IN MODULE INSERTION

See the following picture to insert the plug-in module:

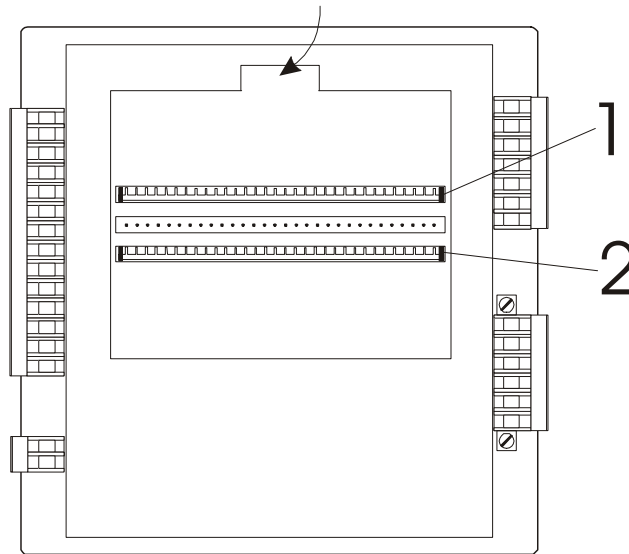

It's only possible to see the two slots, shown in the picture, when the rear door is removed. To remove the rear door it's necessary to act, in the zone indicated of the arrow, on the retention lever.

The first slot is used to insert the option board of the digital input, digital output, analog output and serial port:

- a) 6DI 6 digital inputs
- b) 2DI+2DO 2 digital inputs + 2 digital outputs
- c) 4DO 4 digital outputs
- d) 2AO 2 analog outputs
- e) 4AO 4 analog outputs
- f) COM2 1 serial port

The second slot is used only for the option memory: MEM Ram (1Mbyte).

Warning: if you insert the option board in the wrong slot, you can damage the instrument.

7.1) INSERTION PROCEDURE

Only a qualified and authorized technical person can insert the plug-in module.

Follow this procedure to operate in the maximum security:

- 1) Cut off the power supply of instrument and disconnect all inputs and all outputs.
- 2) Remove the seal from the rear door.
- 3) Open and remove the rear door.
- 4) It's necessary to proceed with a lot of accuracy, without touching other components, because there are residual voltages.
- 5) Before starting the operation of insertion of the plug-in module in the slot number 1, it's necessary to remove the plug in terminals block.
- 6) If you must insert plug-in modules in both slots, it's advisable, but not necessary, to insert before the board on slot number 1 and after the module on slot number 2.
- 7) Insert with a lot of accuracy the module with an angle of 30° in the down direction respect the slot of insertion and with upper position the component side (see the following picture).
- 8) Rotate the board in the upright direction until the two hooks hold the board, which should be at the same level of the slot (see the following picture).
- 9) Close the instrument using the rear door with the hole, in which will enter the plug-in module of the slot number 1. You can use a screwdriver to help you to centre the terminal block with the hole of rear door. It's not necessary to use the rear door with the hole for the memory board of the slot number 2.
- 10) Replace all connections and turn on the instrument. Check in the relative page that the instrument recognizes the board.

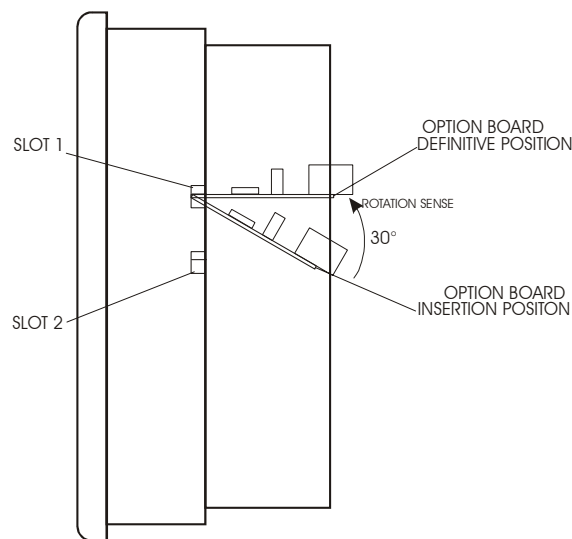

7.2) DISCONNECTION PROCEDURE

Only a qualified and authorized technical person can insert the plug-in module.

Follow this procedure to operate in the maximum security:

- 1) Cut off the power supply of instrument and disconnect all inputs and all outputs.
- 2) Remove the seal from the rear door.
- 3) Open and remove the rear door.
- 4) It's necessary to proceed with a lot of accuracy, without touching other components, because there are residual voltages.
- 5) Push slightly the two hooks, situated on sides, in the external direction using a screwdriver. The module should be disconnected and inclined of 30° in the down direction.
- 6) Extract the plug-in module.
- 7) Close the instrument with the rear door.

8) INPUT/ OUTPUT DEVICES

8.1) STANDARD DIGITAL INPUTS

The EMA11 has 2 opt isolated inputs, power supply from 12 to 24Vdc.

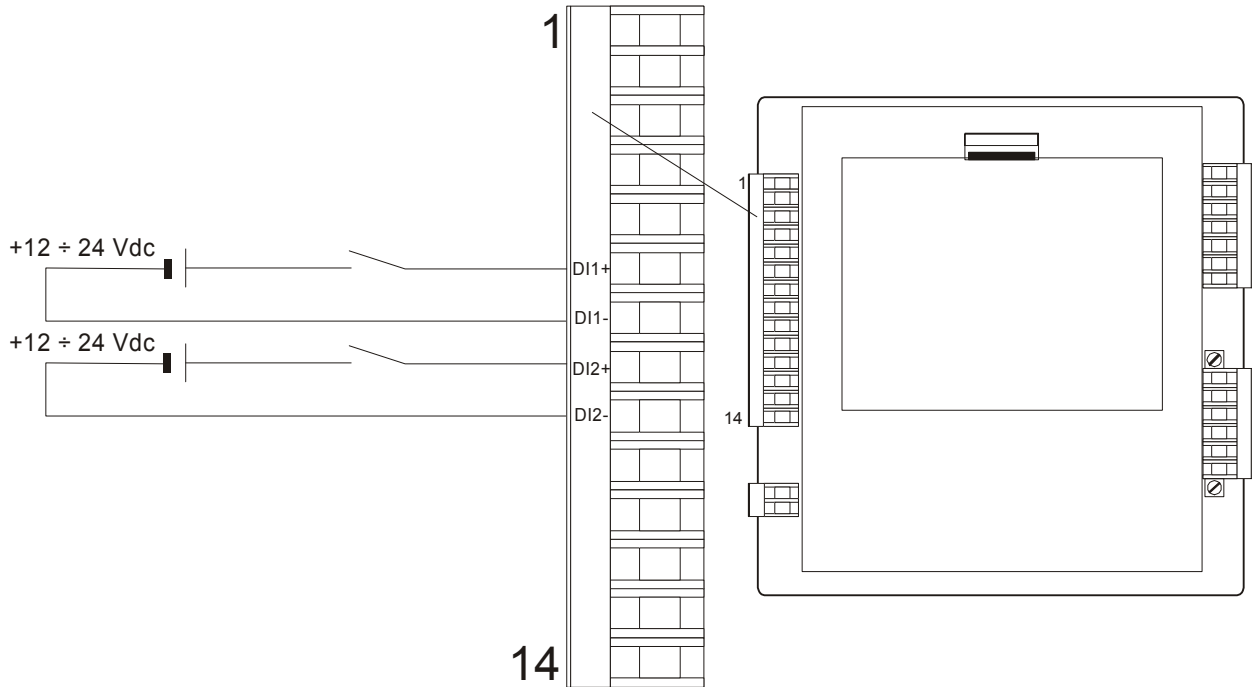

For the digital input setup please consult the chapter 11.9).

If long distances must be covered, the wires connected to the EMA11 needs to be wired in a separate channel from the power supply cables, if an intersection occurs between the power supply cable and the analog wires, please remember to cross the intersection at 90 degrees, in order to cut the generated magnetic fields.

8.2) STANDARD DIGITAL OUTPUTS

The schematic of the 2 standard digital outputs PHOTOMOS of EMA11 is represented on the following figure:

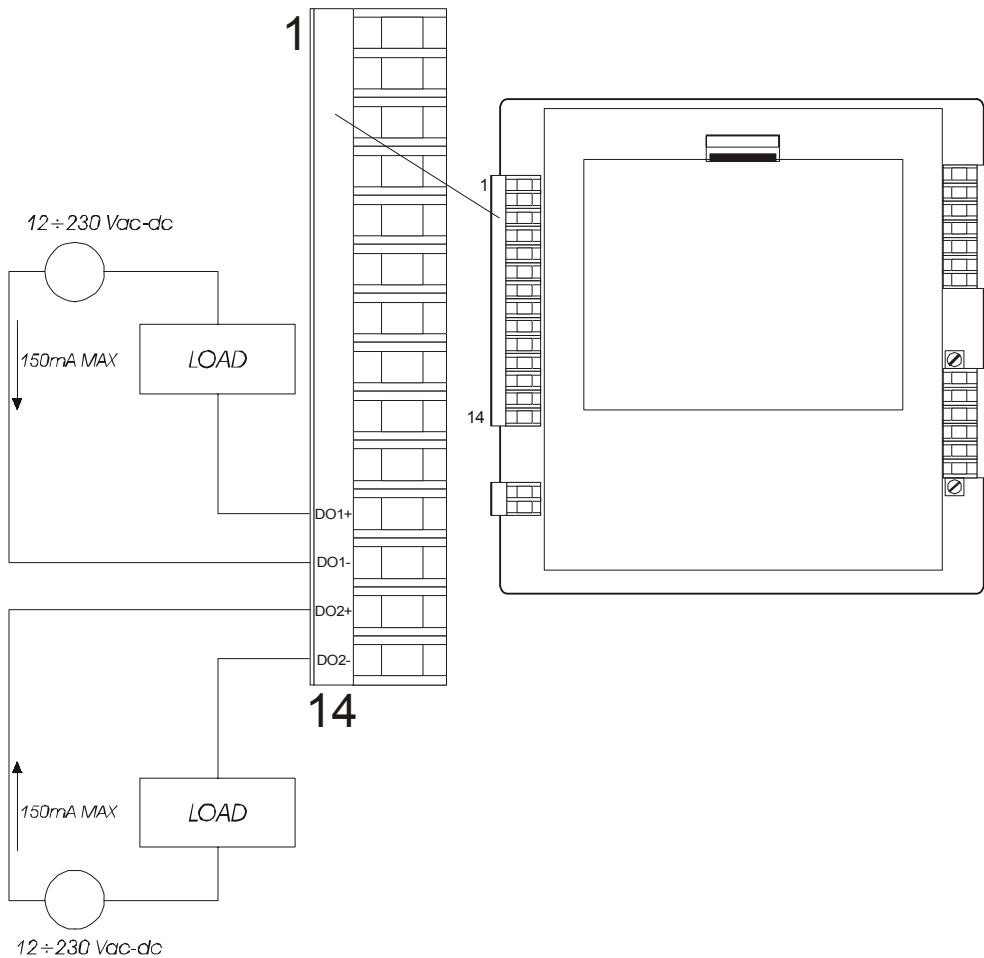

Power supply from 12 to 230 Vac-dc, load must not exceed 150mA, typical resistor value of PHOTOMOS outputs, closed contact, is 8Ω ($R_{ONmax} = 12\Omega$). Each output may be programmed by the operator on min/max threshold, external band, always ON or/and pulse output (consult the chapter 11.8).

The signs + and - on outputs in the picture have electric meaningless.

If long distances must be covered, the wires connected to the EMA11 needs to be wired in a separate channel from the power supply cables, if an intersection occurs between the power supply cable and the analog wires, please remember to cross the intersection at 90 degrees, in order to cut the generated magnetic fields.

8.3) INPUT / OUTPUT OPTIONS (“PLUG IN” MODULE)

It's possible to use this following plug-in module option:

- a) 6 digital inputs (6DI)
- b) 2 digital inputs + 2 digital outputs (2DI+2DO)
- c) 4 static digital outputs (4DO)
- d) 4 relay digital outputs (4DO)
- e) 2 analog outputs (2AO)
- f) 4 analog outputs (4AO)

Warning. The hardware modification of instrument will change the Setup in the default configuration.

The next picture shows the option board position and the terminal block numeration:

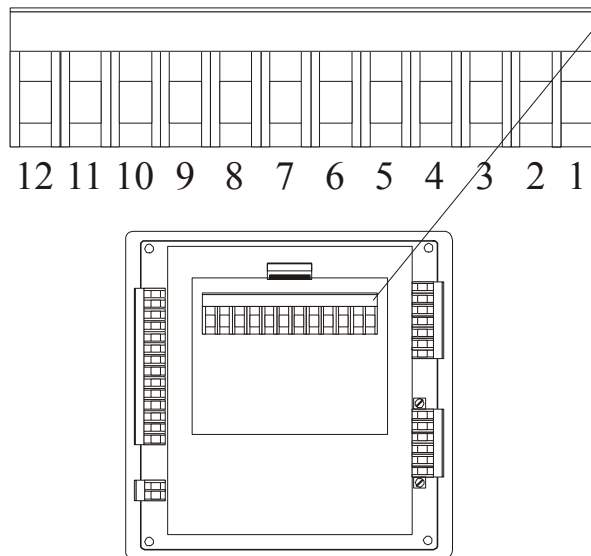

8.3.1) 6 DIGITAL INPUTS OPTION 6DI (“PLUG IN”)

After the installation of this optional board the instrument will be equipped with 8 digital inputs (2 standards + 6 optional) and 2 digital outputs. This module has an output 0-12Vcc usable like power supply for digital inputs. The following table shows the pin-out of this plug-in module:

1	INPUT 3+
2	INPUTS 3- and 4-
3	INPUT 4+
4	INPUT 5+
5	INPUTS 5- and 6-
6	INPUT 6+

7	INPUT 7+
8	INPUTS 7- and 8-
9	INPUT 8+
10	
11	0 Vcc
12	+12 Vcc

8.3.2) 2 DIGITAL INPUTS + 2 DIGITAL OUTPUTS OPTION 2DI+2DO (“PLUG IN”)

After the installation of this optional board the instrument will have 4 digital inputs and 4 digital outputs. See in the following table the pin-out of this plug-in module.

1	OUTPUT 3+
2	OUTPUT 3-
3	
4	OUTPUT 4+
5	OUTPUT 4-
6	

7	
8	INPUT 3+
9	INPUT 3-
10	
11	INPUT 4+
12	INPUT 4-

8.3.3) 4 STATIC DIGITAL OUTPUTS OPTION 4DO (“PLUG IN”)

The option has 4 static digital outputs. The instrument will manage 2 digital inputs and 6 digital outputs (all static’s). The pin-out is showed in the following table:

1	OUTPUT 3+
2	OUTPUT 3-
3	
4	OUTPUT 4+
5	OUTPUT 4-
6	

7	
8	OUTPUT 5+
9	OUTPUT 5-
10	
11	OUTPUT 6+
12	OUTPUT 6-

8.3.4) 4 RELAY DIGITAL OUTPUTS OPTION 4DO (“PLUG IN”)

The option has 4 relay digital outputs. The instrument will manage 2 digital inputs and 6 digital outputs (2 static and 4 relays). The pin-out is the same of the option before.

8.3.5) 2 ANALOG OUTPUTS OPTION 2AO (“PLUG IN”)

This option will allow to manage 2 digital inputs, 2 digital outputs and 2 analog outputs. See the chapter 11.10) to program (0-20mA or 4-20mA) these outputs. The following table shows the pin-out:

1	
2	
3	
4	
5	
6	

7	
8	
9	OUTPUT 2-
10	OUTPUT 2+
11	OUTPUT 1-
12	OUTPUT 1+

Output is at galvanic insulation with maximum load impedance of 150Ω. The connection to other peripherals as recorders, ammeters, remote indicators etc., must be carried out using a maximum cable size of 2.5mm².

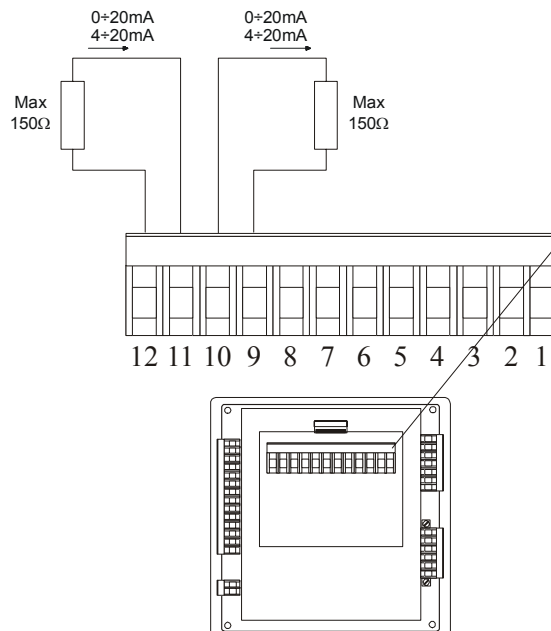

If long distances must be covered, the wires connected to the EMA11 needs to be wired in a separate channel from the power supply cables, if an intersection occurs between the power supply cable and the analog wires, please remember to cross the intersection at 90 degrees, in order to cut the generated magnetic fields.

EMA11 - USER MANUAL

The EMA11 gives a current signal (range 4÷20mA or 0÷20mA) proportional to the measures of the selected parameter. The output is bi-directional: the current can be directly or inversely proportional to reference value programmed. Bi-directional means reversal of reference value and not inversion of current.

Examples:

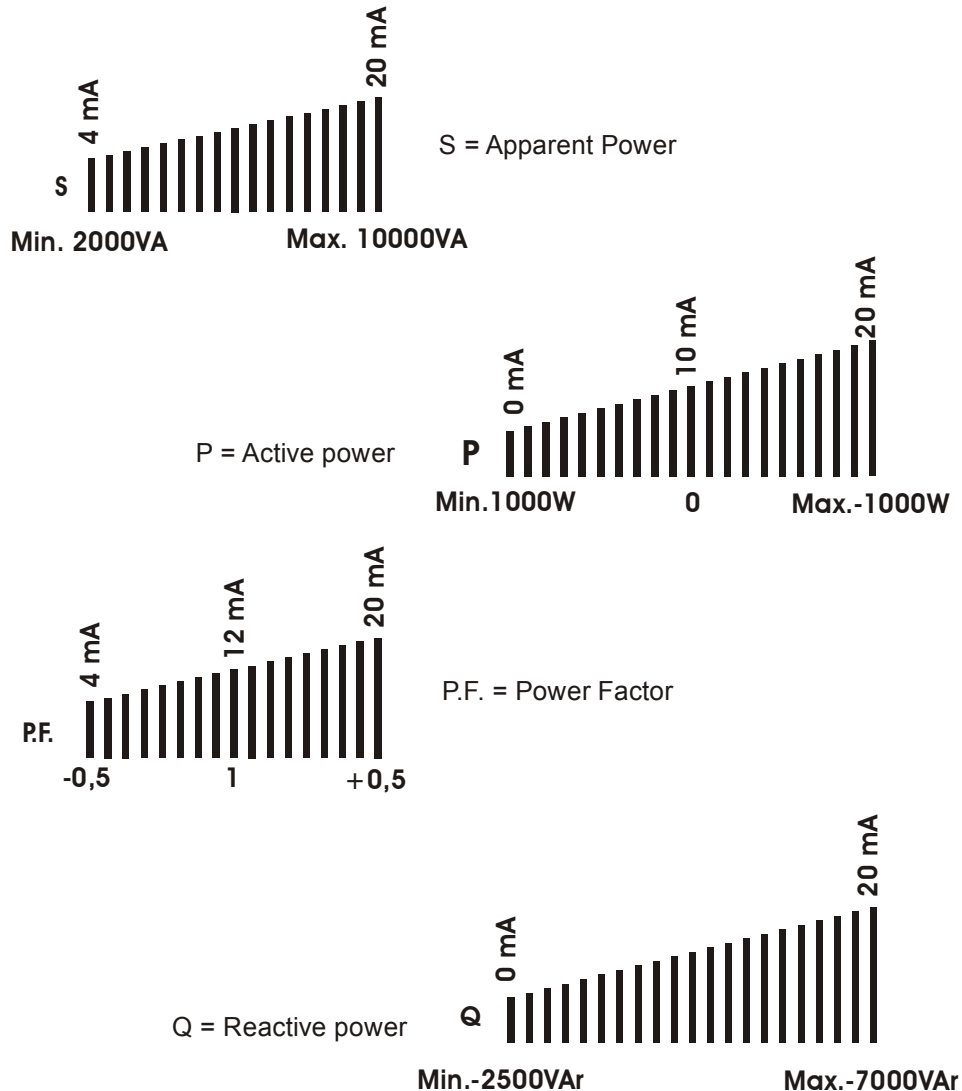

8.3.6) 4 ANALOG OUTPUTS OPTION 4AO (“PLUG IN”)

The instrument with this option will manage 2 digital inputs, 2 digital outputs and 4 analog outputs. The pin-out is showed in the following table:

1	
2	
3	
4	
5	OUTPUT 4-
6	OUTPUT 4+

7	OUTPUT 3-
8	OUTPUT 3+
9	OUTPUT 2-
10	OUTPUT 2+
11	OUTPUT 1-
12	OUTPUT 1+

Information of the connection and example of management of the outputs are explained in the previous paragraph.

8.4) SERIAL OUTPUTS

Through the combination of an asynchronous serial RS485 and RS232 communication line it is possible to exchange information between the instrument and PC, PLC or other compatible systems. All transmitted characters are in ASCII (American Standard Code for Information Interchange) format. RS485 allows a multi-drop connection, in order to link-up several instruments on the same network, on the other hand RS232 allows a single point connection.

This last connection must be carried out when both systems are turned off and disconnected from the power line, in order to avoid damages on the serial output.

RS232 may be 9 or 25 pin connection, please follow up the enclosed table:

Signal	Description	DB9	DB25	EMA11
DCD	Data Carrier Detect	1	8	
RX	Receive Data	2	3	2
TX	Transmit Data	3	2	1
DTR	Data Terminal Ready	4	20	
GND	Signal Ground	5	7	3
DSR	Data Set Ready	6	6	
RTS	Request To Send	7	4	
CTS	Clear To Send	8	5	
RI	Ring Indicator	9	22	

The maximum suggested length of a RS 485 connection is about 1200 mt., while for a RS232 connection about 5 mt.

For longer distances, cables with low attenuation, or connection to line amplifier are recommended. Up to maximum 32 units can be wired on the same serial line (RS485), exceeding this number it is imperative to insert a signal repeater, each repeater can manage up to 32 instruments.

The polling time is directly proportional to the instruments number connected on the same serial line.

8.4.1) RS485 CONNECTION NOT SHIELDED

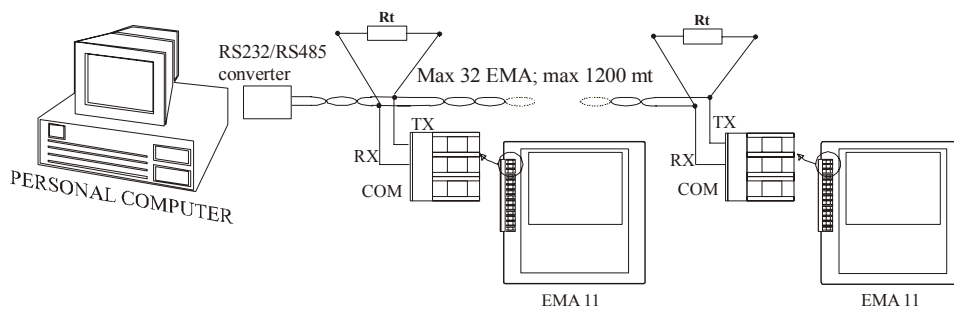

Once a RS485 network has been configured; to communicate between the Host (computer) and the instrument(s) (EMA) a serial interface converter must be wired between PC and instrument(s) as mentioned on the above picture.

In serial line over 500 mt, connect a line termination resistor ($R_t=100\Omega - 120\Omega$) between the two twisted pair cables leading from the converter at the end of the network (last connected instrument).

It's recommended to use always twisted pair cable with minimum cross-section of 0.36mm^2 (22AWG) and capacity less than 60 pF/m (i.e. BELDEN cable type EIA RS485-Ref.3105A).

8.4.2) RS485 CONNECTION SHIELDED

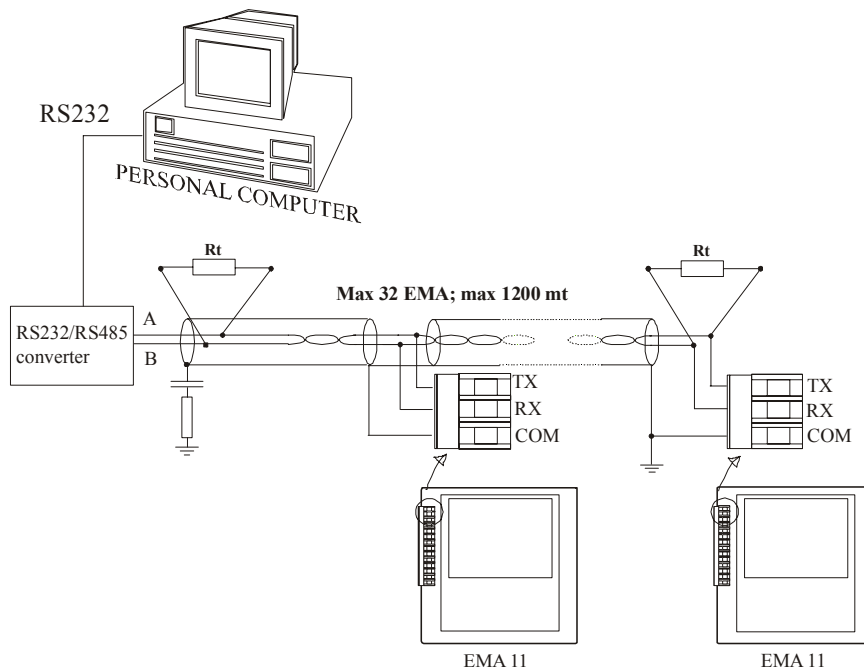

Although the signal is given by the difference between A and B voltage, a ground connection is needed to eliminate or to reduce the common mode noise induced (into the bus).

To reduce the EMI interferences need to connect the shield directly to a ground at one end and with a series RC network at the other end.

$R = 100\Omega$ $C = 33\mu F$.

The max length of the stubs is 20cm.

8.4.3) RS232 CONNECTION

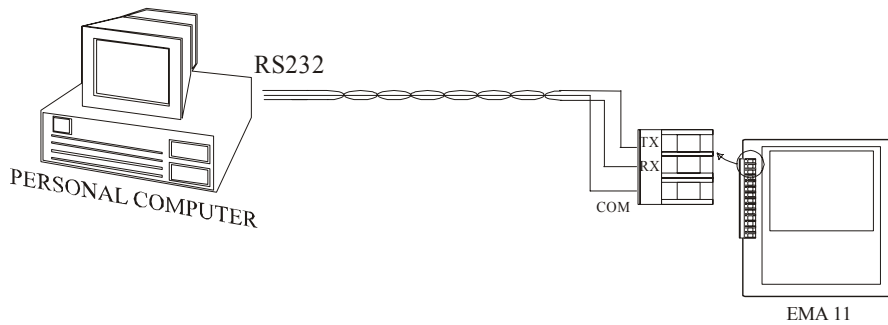

If a RS232 communication line is shorter of 5 mt. and a multidrop network will not use, it's not necessary to use a serial line converter because the serial output is compatible with the PC., as shown on the above mentioned picture.

A RS232 could reach 15mt. but the presence of noises in the industrial application could cause breakdown in the communication.

The connection from EMA serial port RS232 to PC RS232 serial port is a PTP, Pin To Pin, connection.

SIGNAL	EMA11	DB9 (PC)
TX	1	PIN 2
RX	2	PIN 3
GND	3	PIN 5

8.4.4) MODEM CONNECTION

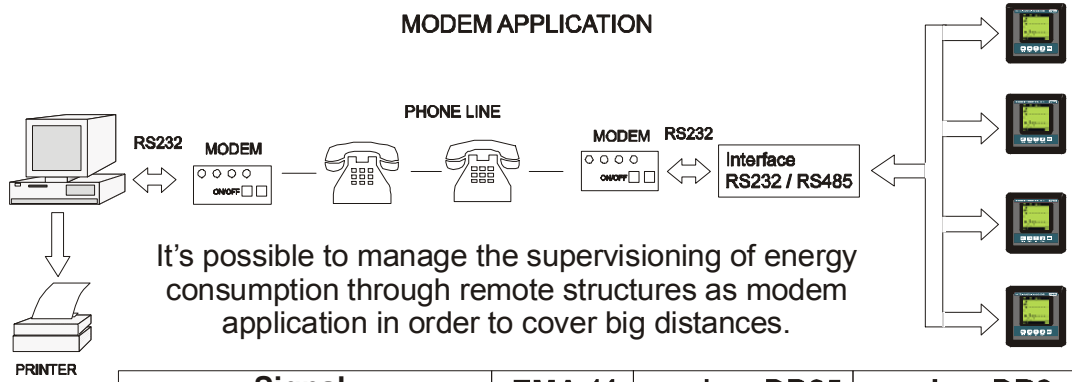

Signal		EMA 11	modem DB25	modem DB9
TX	Transmit Data	1	2	3
RX	Receive Data	2	3	2
Ground	Signal GrouND	3	7	5

To make the remote connection it needs to program the remote modem (connected to the EMA network). To program this modem the user has to use any communication program like HyperTerminal. The Hayes commands to program a standard modem are the following:

```
AT&D0&S0&C0&R1
ATS0=2
ATX3
AT&W0Y0
```

The meaning of the commands is the following (AT is the command prefix):

- &D0: ignore DTR.
- &S0: ignore DSR.
- &C0: ignore CD.
- &R1: ignore RTS.
- S0=2: set at two as the ring number after the which the modem automatically reply (the number can be different by 2, but it must be different by 0).
- &W0: store the configuration in the register 0 of the modem's not volatile memory.
- Y0: set the configuration stored in the register 0 of the modem's not volatile memory as the default configuration at the starting or the reset of modem.

See the modem's user manual.

8.4.5) OPTION RS485/RS232 COM2 ("PLUG-IN")

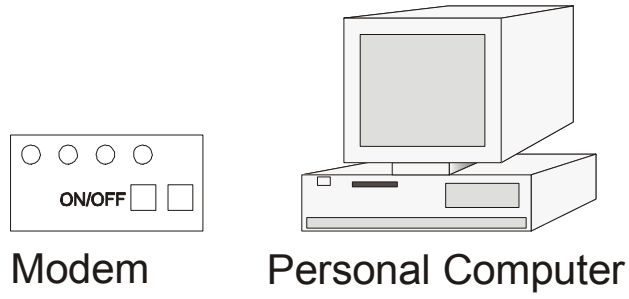

RS485 / RS232

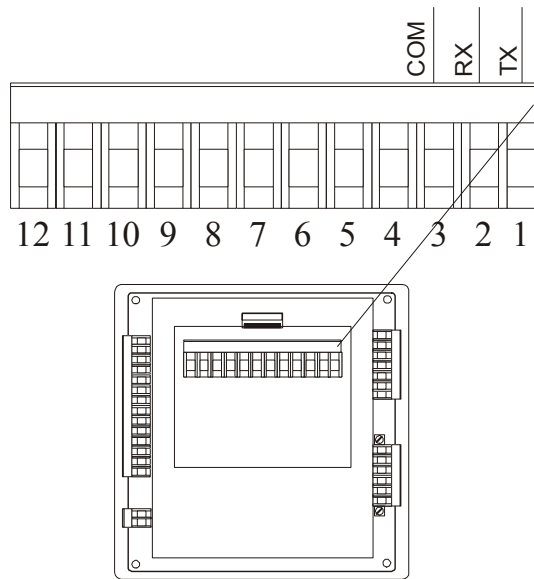

Warning. The hardware modification of instrument will change the Setup in the default configuration.

9) USE

9.1) FUNCTION KEYS

- **UP & DOWN KEYS**

The “UP” and “DOWN” keys allows to skip through the real time pages and to select the programming level or to modify values during the input in the setup menu.

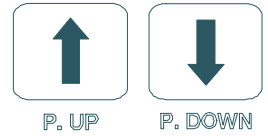

- **LEFT & RIGHT KEYS**

The “LEFT” and “RIGHT” keys allow to visualize the real time sub pages and to move the cursor in the field of input data in the setup menu. To skip from real time pages and to go in the menu setup it’s necessary to press simultaneously both these keys. To come back at real time pages to repeat the same operation. Other functions allow to see average values, minimum and maximum, storage and harmonic components. When it’s possible to accede at these function two little arrows appear on the display’s bottom bar.



- **“ENTER” KEY**

“ENTER” key, if pressed for at least 3 seconds on any of the real time pages (instantaneous value pages) sets the current visualized page as “MAIN PAGE”. In the SETUP menu the “ENTER” key allows to enter in the setting menu or submenu in order to program and/or set values and confirm the operation/s.



- **DISPLAY CONTRAST**

It is possible to regulate the contrast of the display directly from the keyboard, pressing simultaneously the “UP” key with the “ENTER” key, the display will change in lighter. To change the display in darker, it is necessary to press simultaneously the “DOWN” key with the “ENTER” key.

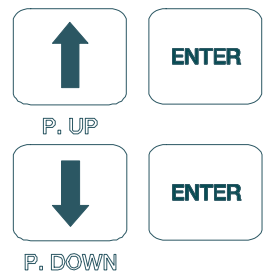

- **SYSTEM RESET**

To reset the unit directly from the keyboard without entering in the Setup menu (where from there it is also possible to reset the unit through Reset Global on chapter 11.11), operator may press simultaneously the 4 arrow keys, after 2 seconds the complete unit will be re-set.

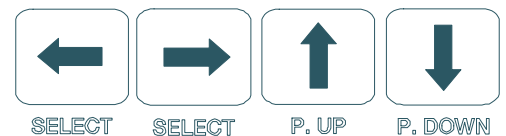

10) REAL TIME VALUES

The real time pages show all the possible performed measurement of the instrument during the evolution. All visualized pages may be set as main page by the operator, this means that the preferred page may be set as the one to be visualized. To set the main page the operator shall press the "ENTER" key for at least 2 seconds, the symbol of the main page is shown with a "#" on the top right side of the display. The visualization of real time measure includes a sequence of principal pages, that it’s possible to see pressing “UP and “DOWN” keys, and secondary pages that it’s possible to see pressing “LEFT” and “RIGHT” keys when these symbols (◀ and ▶) compare.

10.1) VISUALIZATION TREE

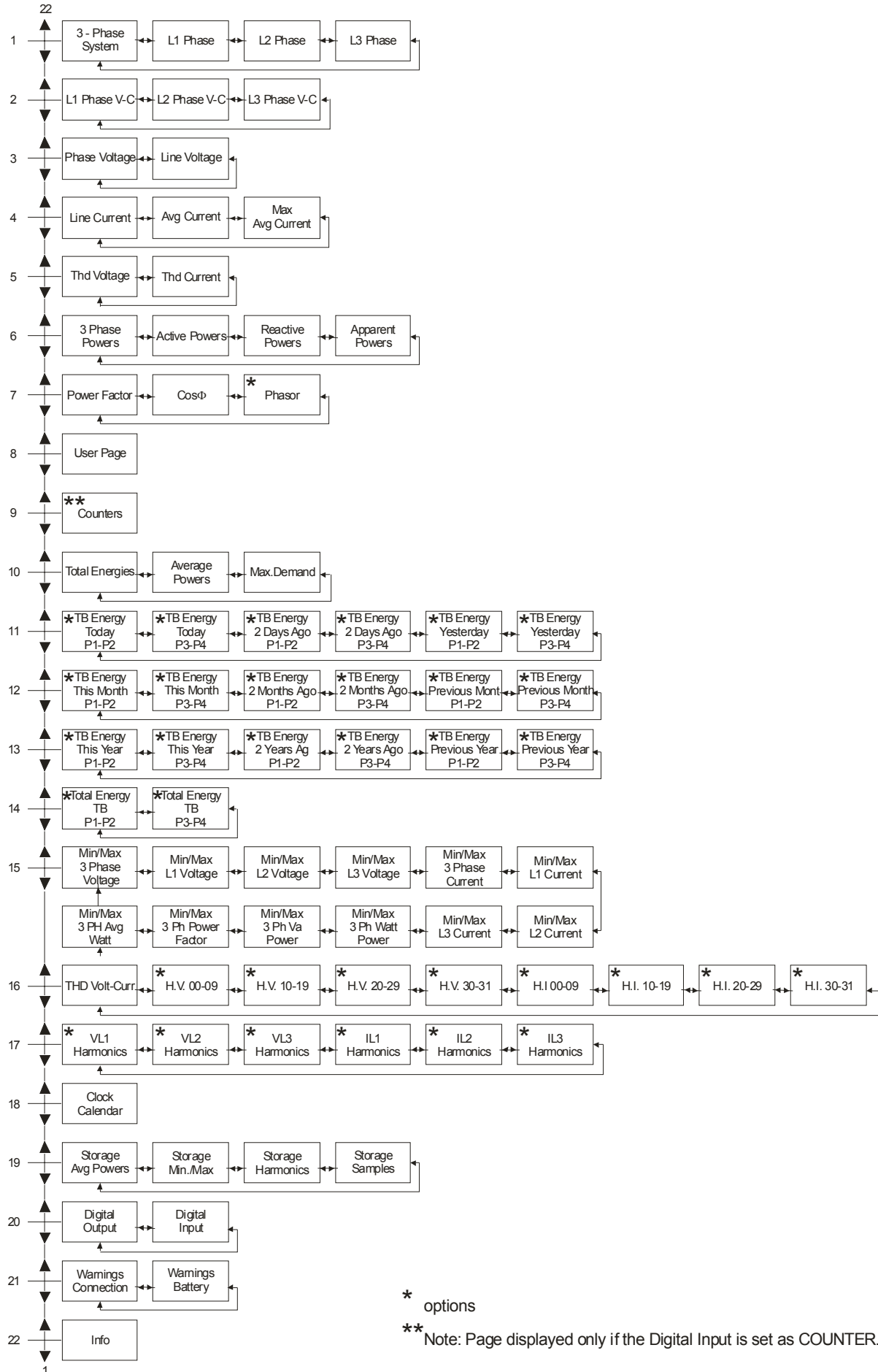

10.2) MEASURES VISUALIZATION

Variable reading of three - phase system

- (V - kV) RMS three - phase system voltage [$\sum V_{L-L}$]
- (A - kA) RMS three - phase system current [$\sum I$]
- (W - kW - MW - GW) three - phase system active power [$\sum W$]
- (PF) three - phase system power factor [$\sum PF$]
- (F) frequency L1 [F_1]

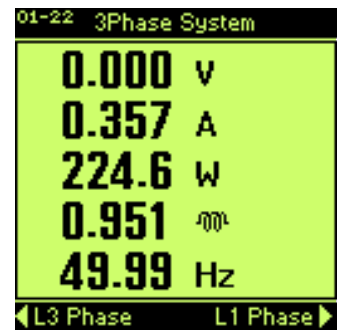

Variable reading of phase L1

- (V - kV) RMS voltage L1 phase [V_1]
- (A - kA) RMS current L1 [I_1]
- (W - kW - MW - GW) active power L1 [W_1]
- (PF) power factor L1 [PF_1]

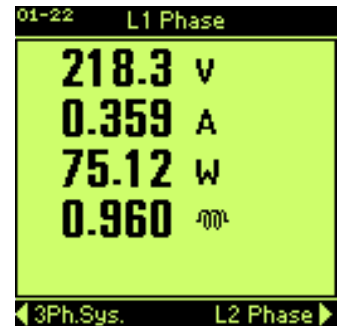

Variable reading of phase L2

- (V - kV) RMS voltage L2 phase [V_2]
- (A - kA) RMS current L2 [I_2]
- (W - kW - MW - GW) active power L2 [W_2]
- (PF) power factor L2 [PF_2]

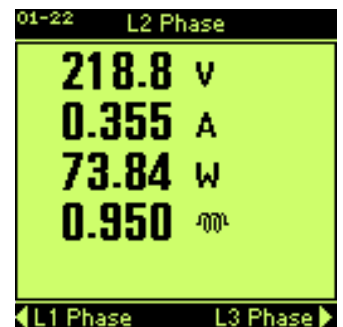

Variable reading of phase L3

- (V - kV) RMS voltage L3 phase [V_3]
- (A - kA) RMS current L3 [I_3]
- (W - kW - MW - GW) active power L3 [W_3]
- (PF) power factor L3 [PF_3]

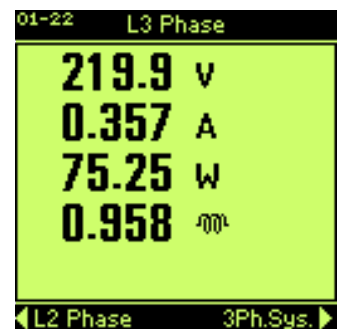

Voltage and current wave forms L1 line

In the "L1 Phase V-C" page are showed the voltage and current wave forms with their peak values and crest factors. The wave form of the current has the lower amplitude.

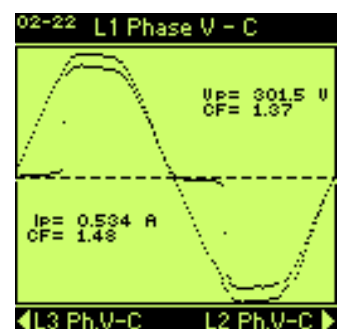

Voltage and current wave forms L2 line

In the “L2 Phase V-C” page are showed the voltage and current wave forms with their peak values and crest factors. The wave form of the current has the lower amplitude.

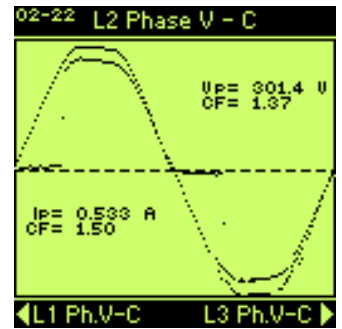

Voltage and current wave forms L3 line

In the “L3 Phase V-C” page are showed the voltage and current wave forms with their peak values and crest factors. The wave form of the current has the lower amplitude.

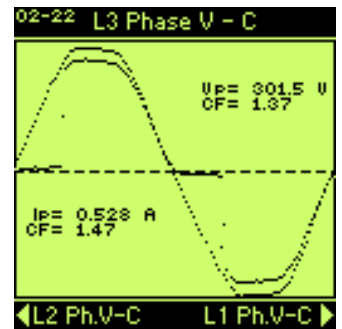

Variable reading of phase voltage

- (V - kV) rms voltage between L1 and L2 [V₁₋₂]
- (V - kV) rms voltage between L2 and L3 [V₂₋₃]
- (V - kV) rms voltage between L3 and L1 [V₃₋₁]
- percentage of unbalance phase voltage [V_{unb}]

Note: the unbalance voltage appears only if it's defined in setup.

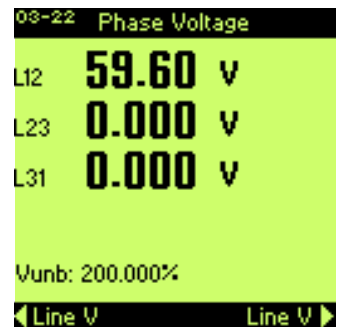

Variable reading of line voltage

- (V - kV) rms voltage L1 [V₁]
- (V - kV) rms voltage L2 [V₂]
- (V - kV) rms voltage L3 [V₃]
- (V - kV) average line voltage [V_{avg}]
- percentage of unbalance line voltage [V_{unb}]

Note: the unbalance voltage appears only if it's defined in setup.

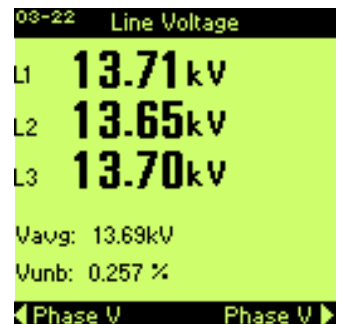

Variable reading of line current

- (A - kA) rms current L1 [I₁]
- (A - kA) rms current L2 [I₂]
- (A - kA) rms current L3 [I₃]
- (A - kA) rms neutral current N (showed only with connection 4 wires) [I_N]

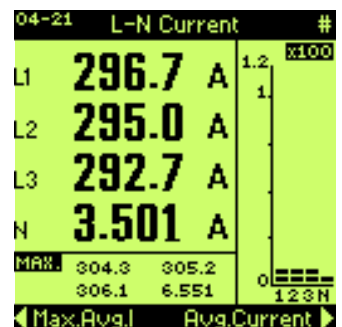

Variable reading average line, three-phase system and neutral current

- (A - kA) rms average three - phase system current [ΣI_{av}]
- (A - kA) rms average current L1 [I_{1av}]
- (A - kA) rms average current L2 [I_{2av}]
- (A - kA) rms average current L3 [I_{3av}]
- (A - kA) rms average current N [I_{nav}]

Note: The average current is calculated in the average time set in the setup. The average neutral current will be showed only if the insertion type is 4 wires.

04-21 Avg.Current #	
ΣL	292.6 A
L1	292.1 A
L2	292.6 A
L3	293.0 A
N	3.813 A
◀ L-N Current Max.Avg.I ▶	

Variable reading maximum average line, three-phase system and neutral current

- (A - kA) rms maximum average three - phase system current [ΣI_{maxav}]
- (A - kA) rms maximum average current L1 [I_{1maxav}]
- (A - kA) rms maximum average current L2 [I_{2maxav}]
- (A - kA) rms maximum average current L3 [I_{3maxav}]
- (A - kA) rms maximum average current N [I_{nmaxav}]

Note: The maximum average current is calculated in the average time set in the setup. The maximum average neutral current will be showed only if the insertion type is 4 wires.

04-21 Max.Avg.Current #	
ΣL	292.0 A
L1	291.1 A
L2	292.3 A
L3	292.4 A
N	4.032 A
◀ Avg.Current L-N Current ▶	

Variable reading THD of voltage

- (Thd) total harmonic distortion of voltage L1 phase [Thd_1]
- (Thd) total harmonic distortion of voltage L2 phase [Thd_2]
- (Thd) total harmonic distortion of voltage L3 phase [Thd_3]

05-22 Thd Voltage	
L1	3.546 %
L2	3.212 %
L3	3.379 %
◀ THD V THD V ▶	

Variable reading THD of current

- (Thd) total harmonic distortion of current L1 phase [Thd_1]
- (Thd) total harmonic distortion of current L2 phase [Thd_2]
- (Thd) total harmonic distortion of current L3 phase [Thd_3]

05-22 Thd Current	
L1	29.20 %
L2	30.32 %
L3	31.34 %
◀ THD I THD I ▶	

Variable reading three-phase powers

- (W - kW - MW - GW) three - phase system active power [ΣP]
- (VAr - kVAr - MVar - GVar) three - phase system reactive power [ΣQ]
- (VA - kVA - MVA - GVA) three - phase system apparent power [ΣS]
- (P.F.) three phase system power factor [ΣPF]

06-22 3Phase Powers	
ΣL	225.5 W
ΣL	51.20 VAr
ΣL	240.0 VA
ΣL	0.939
◀ Apparent P. Active P. ▶	

Variable reading phase active power

- (W - kW - MW - GW) three - phase system active power [ΣP]
- (W - kW - MW - GW) active power L1 [P_1]
- (W - kW - MW - GW) active power L2 [P_2]
- (W - kW - MW - GW) active power L3 [P_3]

06-22 Active Powers	
Σ_L	224.5 W
L ₁	76.06 W
L ₂	74.79 W
L ₃	73.64 W

◀ 3Ph.Powers Reactive P. ▶

Variable reading phase reactive power

- (VAr - kVAr - MVar - GVar) three - phase system reactive power [ΣQ]
- (VAr - kVAr - MVar - GVar) reactive power L1 [Q_1]
- (VAr - kVAr - MVar - GVar) reactive power L2 [Q_2]
- (VAr - kVAr - MVar - GVar) reactive power L3 [Q_3]

06-22 Reactive Powers	
Σ_L	52.02 VAr
L ₁	18.98 VAr
L ₂	17.70 VAr
L ₃	15.34 VAr

◀ Active P. Apparent P. ▶

Variable reading phase apparent power

- (VA - kVA - MVA - GVA) three - phase system apparent power [ΣS]
- (VA - kVA - MVA - GVA) apparent power L1 [S_1]
- (VA - kVA - MVA - GVA) apparent power L2 [S_2]
- (VA - kVA - MVA - GVA) apparent power L3 [S_3]

06-22 Apparent Powers	
Σ_L	230.7 VA
L ₁	76.61 VA
L ₂	77.42 VA
L ₃	76.68 VA

◀ Reactive P. 3Ph.Powers ▶

Variable reading phase power factor

- (P.F.) three phase system power factor [ΣPF]
- (P.F.) power factor L1 [PF_1]
- (P.F.) power factor L2 [PF_2]
- (P.F.) power factor L3 [PF_3]

07-22 Power Factor	
Σ_L	0.911 $\cos\phi$
L ₁	0.917 $\cos\phi$
L ₂	0.910 $\cos\phi$
L ₃	0.905 $\cos\phi$

◀ CosFi CosFi ▶

Variable reading phase cosφ

- (cosφ) three phase system cosφ [$\Sigma \cos\phi$]
- (cosφ) cosφ L1 [$\cos\phi_1$]
- (cosφ) cosφ L2 [$\cos\phi_2$]
- (cosφ) cosφ L3 [$\cos\phi_3$]

07-22 Cos Fi	
Σ_L	0.970 $\cos\phi$
L ₁	0.969 $\cos\phi$
L ₂	0.966 $\cos\phi$
L ₃	0.974 $\cos\phi$

◀ P.Factor P.Factor ▶

Phasor (option)

Fresnel diagram.

Phase angles in degree, voltage, current and PF for each line.

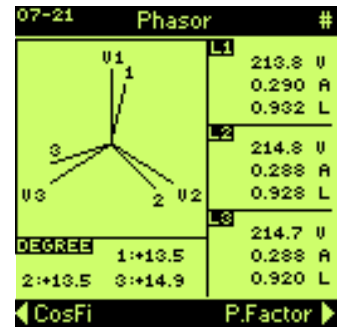

User page

The user can define in the setup menu (General-User Page) the variables to display in this page.

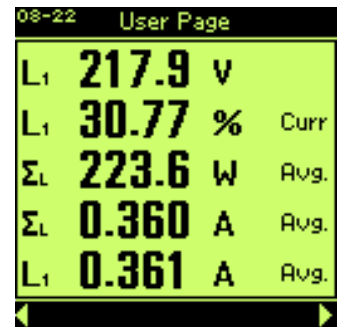

Variable reading counters

This page shows the 8 counters available.

Note: These pages appeared only if the digital inputs are set like COUNTERS.

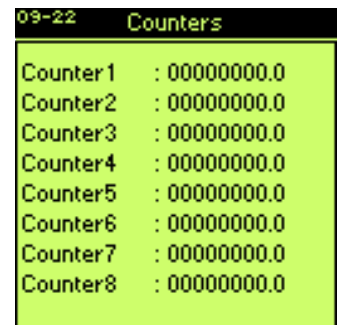

Variable reading consumption of active and reactive energy (Normal)

- (kWh) positive active energy counter [kWh+]
- (kWh) negative active energy counter [kWh-]
- (kVArh) inductive reactive energy counter [kVArh+]
- (kVArh) capacitive reactive energy counter [kVArh-]

Note: If Energy Type is set like Heavy the measure units are expressed in MWh and MVARh.



Variable reading average powers

- (W - kW - MW - GW) average active power [P]
- (VAr - kVAr - MVar - GVar) average reactive power [Q]

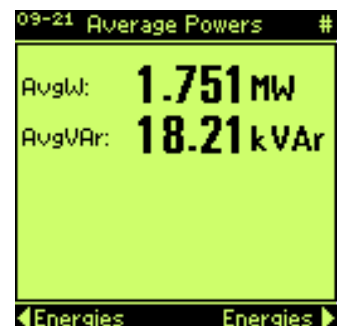

Max.Demand

Max demand of each band and total.

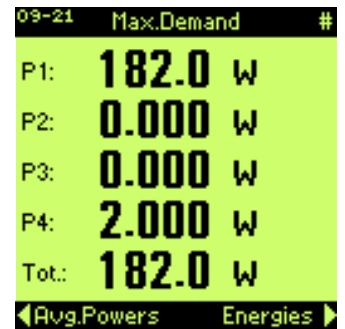

Variable reading time-band energy counters (option)

20 pages to display the active energy counters (positive and negative) and reactive (capacitive and inductive) divided in 4 programmable time bands (P1 - P2 - P3 - P4).

The 20 pages are: consumption present year and the two previous, consumption present month and the two previous, consumption of today and the two day previous, and total counter of bands.

In a voice of menu setup (paragraph 11.6) it's possible to program times, days and months in which the energy count is added at the different bands.

External signals, connected to digital inputs, and with a right programming, can change the bands in the time.

If the energy is Heavy the values are displayed in MWh and MVarh.

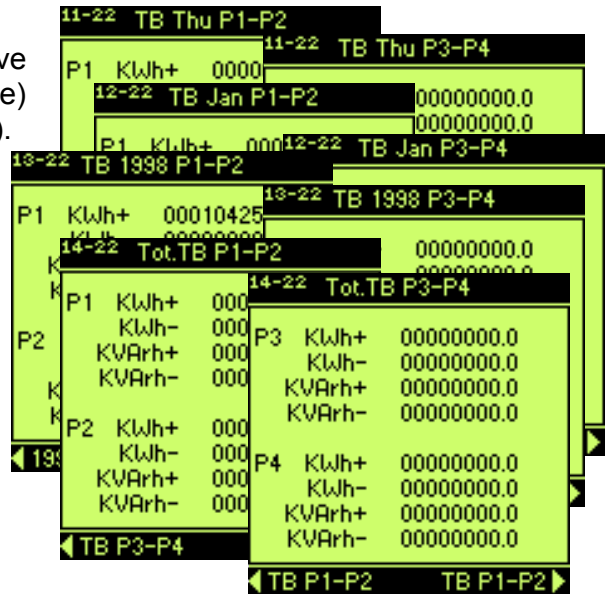

Variable reading MIN & MAX values

12 pages (selected by "left" and "right" keys) show minimum and maximum of the value of 12 parameters taken after last reset. Date and time of reading are displayed on these pages.

It's possible to see the values of these parameters:

- three - phase system voltage (ΣV_{L-L})
- L1 phase voltage (V_{L1})
- L2 phase voltage (V_{L2})
- L3 phase voltage (V_{L3})
- three - phase system current (ΣI)
- L1 phase current (I_{L1})
- L2 phase current (I_{L2})
- L3 phase current (I_{L3})
- three - phase system active power (ΣW)
- three - phase system apparent power (ΣVA)
- three - phase system power factor (ΣPF)
- three - phase system average active power (ΣW_{av})

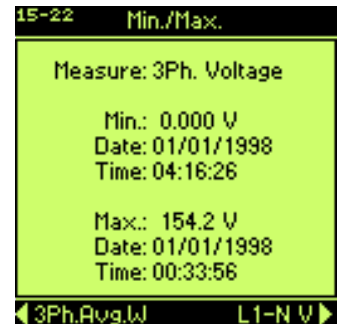

Variable reading Thd of voltage and current (harmonics orders option)

A page shows the total harmonic distortion of voltage and of current:

- (Thd) total harmonic distortion of voltage L1 phase [Thd₁]
- (Thd) total harmonic distortion of voltage L2 phase [Thd₂]
- (Thd) total harmonic distortion of voltage L3 phase [Thd₃]
- (Thd) total harmonic distortion of current L1 phase [Thd₁]
- (Thd) total harmonic distortion of current L2 phase [Thd₂]
- (Thd) total harmonic distortion of current L3 phase [Thd₃]

8 pages show the harmonic components (up to 31st) of voltage and current of each line in numerical form.

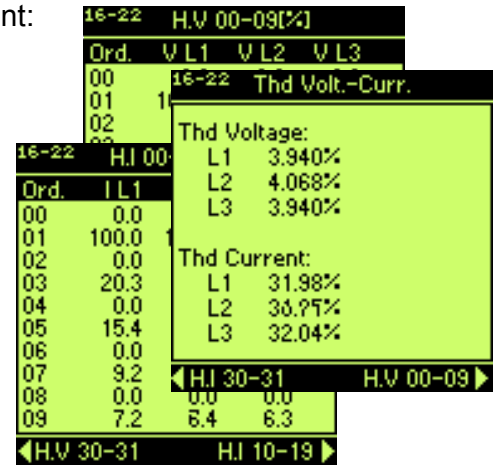

Variable reading total harmonic distortion and harmonic components of voltage and current (option).

6 pages of visualization of THD and harmonic components (up to 31st with fundamental frequency 50-60Hz) of voltage and current of each line expressed in numerical and graphic form. Once entering in the harmonic analyzes page, it may be possible with the right + enter & left + enter keys to page through the order of the harmonics up to the 31st. The pages show the histograms, the order of the harmonic and value referred to the fundamental.

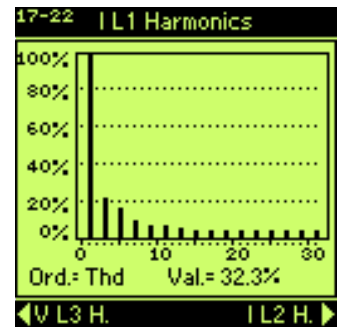

10.3) STATUS AND INFORMATION PAGES

The status and/or information pages include:

- the displaying of clock and internal calendar
- the condition of internal RAM memory
- the condition of digital I/O
- warnings
- general info of the instrument

Clock/Calendar

- time format: hours, minutes, second (hh:mm:ss)
- date format: day, month, year (dd/mm/yyyy)
- day of the week



Condition internal RAM memory

4 pages (selectable with "LEFT" and "RIGHT" keys) of information on condition internal RAM memory.

The internal memory is divided in 4 sections:

- storage values average powers [Avg. Powers]
- storage values relative minimum and maximum [Min/Max]
- storage values harmonic components [Harmonics]
- storage values samples [Samples]

Each section is displayed in own sub page.

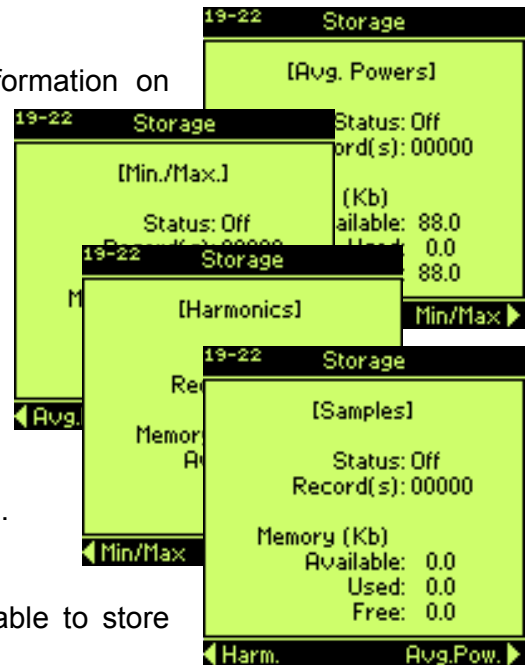

The page shows the following information:

- **Type of section of memory** (for examples samples).
- **Status**, "ON" if memory enabled or "OFF" if memory disabled.
- **Record(s)**, number of stored events in memory.

Memory (Kb)

- **Available**, static memory, expressed in Kb, which is available to store data for this section.
- **Used**, dynamic memory, expressed in Kb, which is used by data already stored (record stored).
- **Free**, dynamic memory, expressed in Kb, which is free to store data.

Used & Free memory are working together, blocks of memory are transferred from **Free** memory to **Used** memory in order to store the values on the RAM of the instrument. Initially the available memory will be totally free but at own exhaustion it will be totally used. These information are very important to avoid to delete stored data, to choose how to storage the data on the basis of available memory.

Digital I/O

The page shows the "ON" "OFF" status of the digital inputs and digital outputs.

The symbol "---" indicates that none output/input is present on the hardware (these are inputs / outputs optional).

16-22 Digital I/O			
16-22	Digital I/O	Dig.Output 01	Off
	Dig.Input 1	Off	Dig.Output 02
	Dig.Input 2	Off	Dig.Output 03
	Dig.Input 3	---	Dig.Output 04
	Dig.Input 4	---	Dig.Output 05
	Dig.Input 5	---	Dig.Output 06
	Dig.Input 6	---	Dig.In
	Dig.Input 7	---	
	Dig.Input 8	---	

Warnings

To see “warnings” are available 2 pages.

The first page shows the situation of the connection of the instrument, regarding the connection of current transformer in the current input and the phase sequence for the voltage input. If at least one of current transformer is inverted, the display shows “Warning TA”, otherwise “TA OK”. If the sequence of phases at voltage inputs is inverted will appear “WARNING!”, otherwise “Phases sequence OK”. The message “No Info, Please Wait” appears during the elaboration to establish the phase’s sequence.

The information on phase, appears only if the three phase system voltage is higher of 10V, otherwise the display shows: “Low voltage, No Info”.

If the voice of menu Setup | General | Warnings is “Yes”, the warnings page of inversion of current transformer and phases sequence will be display automatically alternatively at the default page each time that happens an inversion.

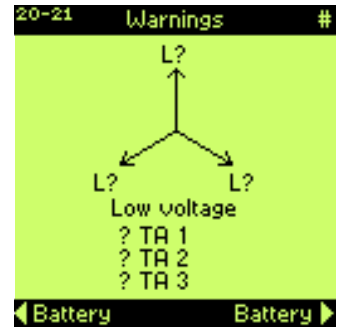

The second page shows the situation of internal battery.

If the voltage level of internal battery is lower of 2.3V on display will appear “Battery LOW”, otherwise “Battery OK”. This page will be displayed independently of the voice of menu Setup | General | Warnings when the voltage level is lower of 2.3V.

Warning. If there’s no battery or its voltage level is lower than 2.3V the instrument will lose all storing data in RAM, minimums, maximums, energy counter, and the setup).



General info

Information page shows the main instrument configuration as model, firmware version, serial number, inputs/outputs configuration, protocol communication, etc.

These information’s identify the instrument and its configuration before possible upgrade and for this reason they are very important.

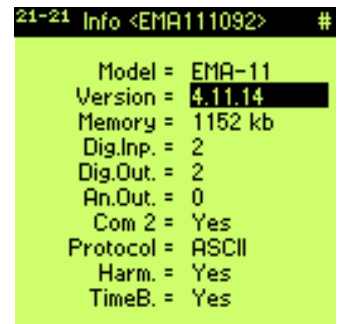

11) SETUP

11.1) SETUP ITEMS

GENERAL

KCT (0.01÷5000)
 KVT (0.01÷5000)
 Mode (4 wires -3 wires -Aron)
 Measure Time(0÷50 sec.)
 Warnings (Yes-No)
 B.Light (0÷360)
 DefPage Time (10÷900 sec.)
 SYNC.
 Mode(EXT-INT)
 Freq. (5÷500)

CLOCK

Set Clock
 Day Light (Enable-Disable)

PASSWORD

Value (0000÷9999)

ACCESS (000000÷999999)

User Page

Measure 1 (list of parameter)

 Measure5 (list of parameter)

V Unbalance (V_{LL}-V_{LN})

SERIAL COMM

Protocol (ASCII; Modbus)
 Address (Modbus: 01÷255; ASCII: 01÷128)

COM1

Baud (1200÷19200)
 Parity(none-even-odd)
 DataBit (7-8)
 Type (RS232-RS485)

COM2

Baud (1200÷19200)
 Parity (none-even-odd)
 DataBit (7-8)
 Type (RS232-RS485)

AVERAGE

Sync Avg (Int.Rtc-Ext.DI-Int+Ext)
 Type (fixed-Mobile)
 Time Avg (1-2-3-5-6-10-12-15-20-30-60)
 dt Mobile (10"-20"-30"-1'-2'-3'-5'-10'-15'-20'-30')

ENERGY

Type (Normal-Heavy)

PRESET

ENERGIES

KWh+ (0÷99999999.9)
 KWh- (0÷99999999.9)
 KVArh+ (0÷99999999.9)
 KVArh- (0÷99999999.9)

COUNTERS

Counter1 (0÷99999999.9)

 Counter8 (0÷99999999.9)

TIMEBANDS

Update day (1÷31)
 Period Id (01÷15)

BAND

Start
 Month
 Day
 Stop
 Month
 Day
 WeekDay
 Time1
 StartHour
 StartMin
 Type (P1,P2,P3,P4,P5,P6,P7,P8)

 Time12
 StartHour
 StartMin
 Type (P1,P2,P3,P4,P5,P6,P7,P8)

HOLIDAYS

Day Index (1÷40)
 Month (1÷12)
 Day (1÷31)

STORAGE

MIN MAX

Enable (On-Off)
 Measures (list of parameters)
 Rate-min. (1÷9999)
 AVG.POW.Enable (On-Off)
 HARM. Enable (On-Off)

DIGITAL OUTPUT

Out Index (1÷6)
 Type (AlwaysOff-EnergyPulse-Min.Threshold-MaxThreshold-Band-AlwaysOn)
 Measure Code (list of parameters)
 Value
 Time (50÷500)
 Hysteresis (0÷99)
 Inf Value
 Sup Value

DIGITAL INPUT

Type (Not used, Clock Sync., Period, Counters, Ext.DI)

COUNT->INPUT

K1Dig.Inp. (0÷8)

 K8Dig.Inp. (0÷8)

COUNTER NAME

Cnt1(User Def,KWh+,KWh-,
 KVarh+,KVarh-,Water,Gas)

 Cnt8(User Def,KWh+,KWh-,
 KVarh+,KVarh-,Water,Gas)

SET WEIGHTS

K1(0÷1999.99)

 K8(0÷1999.99)

ANALOG OUTPUT

Out Index (1÷4)
 Type (0-20mA; 4-20mA)
 Measure Code (list of parameters)
 Min.
 Max.

RESET

RESET MEASURES

All (Yes-No)
 Energies (Yes-No)
 TimeBands (Yes-No)
 Min/Max (Yes-No)
 Reset Setup (Yes-No)
 Reset Storage (Yes-No)
 Reset Counter (Yes-No)
 Reset Max.Demand (Yes-No)
 Reset Global (Yes-No)

EXIT SETUP

Note:

Remember always to confirm the entering, exiting or programming always with the "ENTER" key, the last modification will be kept in the non volatile memory of the equipment until further reset of the system.

11.2) MAIN MENU SETUP

The main menu or SETUP page is configured in the following way:

- **GENERAL**, includes the settings of KCT (current ratio), KTV (voltage ratio), MODE (4 wires, 3 wires, Aron), MEASURE TIME (time constant of measure filter), WARNINGS, B.LIGHT (Backlit on display timing), DEF. PAGE TIME (time of wait before to come back to default page), SYNC. (frequency synchronization), CLOCK (clock settings), PASSWORD (pin-code to avoid that someone not authorized could modify the setup), ACCESS (code to enable option function like harmonics and/or time-bands), USER PAGE (to set the measures to display in user page) and V UNBALANCE.
- **SERIAL COMM**, includes the settings of PROTOCOL (ASCII or MODBUS), ADDRESS (logical number, node or address), COM1 (serial port 1, integrated), COM2 (serial port 2, expansion board).
- **AVERAGE**, includes the settings of SYNC. AVG (synchronism of calculation average), TYPE (fixed or mobile), TIME AVG (integration time for the calculation of the average parameters) and DT MOBILE (sliding time of window mobile).
- **ENERGY**, includes the setting of TYPE (energy counters in kWh or in MWh), PRESET (allows to set the initial value of total ENERGY counter and the generic COUNTERS) and TIMEBANDS (with all parameters to manage the power consumption in different periods)
- **STORAGE**, includes the settings of MIN/MAX, AVERAGE POWERS, HARMONICS (harmonic storing up to the 31st order for both current and voltage for each line).
- **DIGITAL OUTPUT**, sets the OUT INDEX number of digital output, TYPE (type of alarm; always on, max. threshold, min. threshold, external band, energy pulse, always off), MEASURE CODE (the parameter to associate with the digital output), VALUE (the value to set as threshold or, pulse), TIME (delay time by enabling the digital output or duration of impulse), HYSTERESIS, INFVALUE and SUPVALUE (lower value and higher value for alarm of external band).
- **DIGITAL INPUT**, sets the type of acquisition: Not used, Clock Synchronization, Periods, Counters (INPUT, NAME, WEIGHT) or External Synchronization.
- **ANALOG OUTPUT**, set the analog output number, OUT INDEX, TYPE (disable, 0-20mA and 4-20mA), MEASURE CODE (the parameter to associate at analog output), MIN and MAX (lower value and higher value of the variable to associate at current output).
- **RESET**, allows to make a RESET MEASURES, RESET SETUP, RESET STORAGE, RESET COUNTER, RESET MAX DEMAND and RESET GLOBAL.
- **EXIT SETUP**, allows the operator to exit from the main menu or setup page in order to reach the instantaneous value page. Before exiting the page the instrument will question the operator if he might to save the STORAGE Setup in case one or more parameters have been modified.

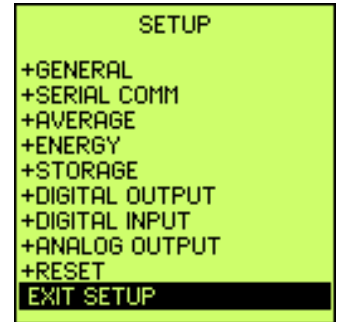

All the above mentioned voices will be described on the following chapters.

11.3) GENERAL

The general menu is subdivided in the following sub menu: KCT (current transformer ratio), KVT (voltage transformer ratio), Mode (type of connection), Measure Time (filter time in the visualization measure), Warnings, B.Light (display backlight on time), Def. Page Time (the time before to come back to default page), Sync. (frequency synchronization), Clock (clock and calendar), Password (setup), Access (code for option function), User Page and V Unbalance.

- **KCT**, allows to set the current transforming ratio, if CT is used, in order to show the measured values in primary terms. The KCT range is 0.01÷5000.00.
EMA11 standard: KCT = external CT rate. If CTs are not used set KCT=1 (I.e.: Set the KCT=40 if the current transformer of 200/5A is used).
EMA11-1A: KCT = external CT rate / 5. If CTs are not used set KCT=0.2 (I.e.: Set the KCT=40 if current transformer of 200/1A is used).
- **KVT**, allows to set the voltage transforming ratio, if VT is used, in order to show the measured values in primary terms. The KVT range is 0.01÷5000.00. (I.e. Set the KVT=200 if voltage transformer of 20000/100V is used).
- **Mode**, concerns the operation or measuring mode, it is possible to select 4 wires, 3 wires and Aron, following the connection mode as described on chapter 6.4).
- **Measure Time**, is the filter time in the visualization measure. The range is 0÷50. The 0 value indicates none average on the measures, others values indicates the average time (in seconds). If this value is very big and the average powers storing is active, the values stored could be wrong. It's better to set a value less than 5 seconds.
- **Warnings**, enables [Yes] or disables [No] the visualization every 15 second of the warnings page alternatively at default page if current transformer connection is wrong or there is an inversion of the phase sequence. The condition of battery low, it will appear independently of the set of this voice.
- **B.Light**, is the time (from 0 to 360 seconds) in which the display remains on, after the keyboard's inactivity. To hold the display always on, it has to be set the value as 0. The brightness of display declines about 10% every 1000 hour of work.
- **Def. Page Time**, is the time of wait before to come back to default page. Range 10÷900 seconds.
- **Synchronization**, to set the fundamental frequency.
Mode: internal or external (V_{L1}).
Freq.: programmable frequency value (range 5÷500Hz).
- **Set Clock**, sets the internal clock of the instrument with relative date. The format of the date is: dd:mm:yy and of the time is: hh:mm:ss
Day Light allow to set the yearly summer time change. It's possible to enable the time shift of the summer time and the return at the solar time at the fixed data. The instrument manages the summer time from the 1997 to the 2030.
- **Password**, it's possible to set a numeric password to modify the SETUP. The default password is 0000: the setup can be always opened and it's always possible to change any parameter. If the password is different by 0000 (from 0001 to 9999), at the entrance of setup, the password will be request. if the password is ignored, it will be possible to see every parameter but it will be impossible to modify it. Only with the correct password it's possible to change every parameter. To set the new password as 0000, the instrument come back at default status. Call the constructor to have an emergency password if you lose the password.
- **Access**, allows to input a code of 6 digits to enable the calculation end the visualization of the harmonics and/or the time-bands. These options are both enabled if it's an H instrument: the code is on a report. These options are disabled if it's an L instrument but one or both can be enabled. To make this it's necessary to give the serial number and the option(s) to enable at Megacon that will send the access code corresponding at the instrument and the selected option(s).
- **User Page**, allows to input 5 chosen from a parameters list to visualize in the relative page.
- **V Unbalance** allows to calculate the voltage unbalance between the line voltage or phase voltage.

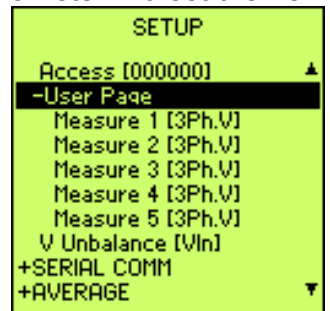
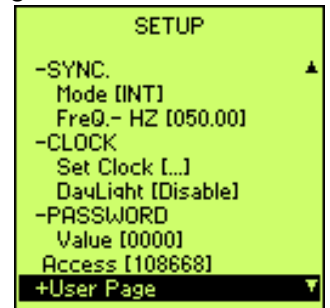
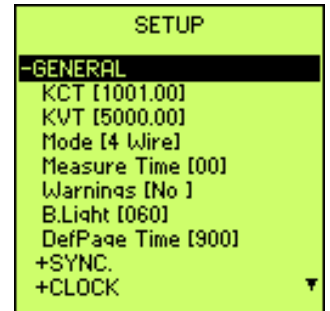

11.4) SERIAL COMM

The SERIAL COMM menu allows the programming of the communication parameters of the COM1 and the option COM2.

- **Protocol**, can be chosen between ASCII and MODBUS.
- **Address**, is the address, node or logic number from 01 to 255 in MODBUS or from 01 to 128 in ASCII. This number identifies the node in a network and consequently the instrument or the peripheral of a serial multidrop network.

This parameter is set freely. This parameter is set automatically using NRG software with ASCII protocol while with MODBUS protocol it must be set.

- **COM1/COM2**, are configured by the following submenus:
 - **Baud**, transmission speed, programmable from 1200 to 19200 bps.
 - **Parity**, parity sequence, programmable NONE-EVEN and ODD.
 - **DataBit**, number of data bits, programmable 7 or 8 bit.
 - **Type**, type of serial output to manage.
COM1 may manage RS485 or RS232.
COM2 may manage RS485 or RS232.

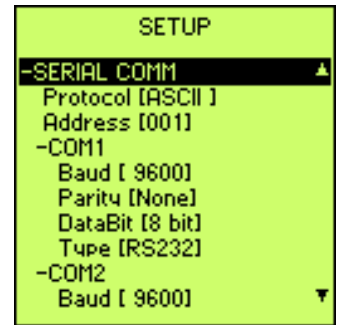

11.5) AVERAGE

The AVERAGE menu allows the settings of parameters in the calculation of average values.

- **Sync Avg**, defines the type of the synchronism for the start and the stop of the average calculation. Three mode of use are available:
 - **Int.Rtc.:** use the internal clock as time based line. The average calculation start when the clock changes the minute.
 - **Ext.DI:** use the digital input 2 (Di2) to synchronize the start and the stop of the average calculation. The digital input will be set as ExtDI automatically.
 - **Int+Ext:** mixed mode. The digital input will be set as ExtDI automatically. No congruent operation of digital input type and Sync. Avg will involve the visualization of the warning message on the display (see for example in this figure).
- **Type**, defines the type of the window used to the average calculation: fixed (the updating depends of the Average time) or mobile (the updating depends of dt Mobile).
- **Time Avg**, integration time for the calculation of the average parameters.
- **dt Mobile**, defines the updating time in window mobile of the average parameters.

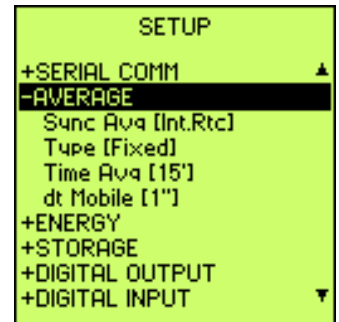

11.6) ENERGY

In the ENERGY menu it's possible to modify the unit of measurement of energies, to set at the initial value the generic and energy counters, to manage on the time-bands.

- **Type**, allows to choose the unit of measurement for the energy counter kWh (Normal) or MWh (Heavy).
- **PRESET**, allows to set at initial value the energy counters and generic counters.

- **ENERGIES**, it's possible to set energy total counters at initial value. These values are expressed in kWh and kVArh; the visualization on total energies page will be congruent with the type of energy (Normal or Heavy). The time bands counters don't consider the preset values. Only total energy counters consider these values.

This function is useful for example to compare the consumption with an energy counter already in use.

- **COUNTERS**, it's possible to set the 8 generic counters at initial value.

- **TIMEBANDS**, it's possible to subdivide the energy consumption in 12 time bands. In this way it's possible to value the energy costs where the energy suppliers apply the time band tariff or it's necessary to divide the consumption in different period. To program the time bands function to accede at the TIMEBANDS menu with the following sub menu:

- **Update day**, sets the day in which change the month in the time bands (range 0÷31). If the value is 0, from the last day of each month the energy is increased in the counter of the next month. If the value is between 1 and 15, from the day fixed the energy is increased in the counter of the actual month, before of this value the energy is increased in the previous month. If the value is between 16 and 31, from the day fixed the energy is increased in the counter of the next month, before of this value the energy is increased in the actual month. If the actual month has fewer days than the value fixed, the energy will be increased into the next month counter from the last day of the month.

- **Period Id**, period number. 15 periods to set different time bands. For each period it's possible to program:

- **BAND**, to program the selected period.

- **Start / Stop**, to program the start and the stop of the selected period.

Month, is a number from 1 to 12 that defines the months (1 January, 2 February, ecc.) of the year corresponding at the start (or the end) of the selected period.

Day, is a number from 1 to 31 that defines the day of the month corresponding at the start (or the end) of the selected period.

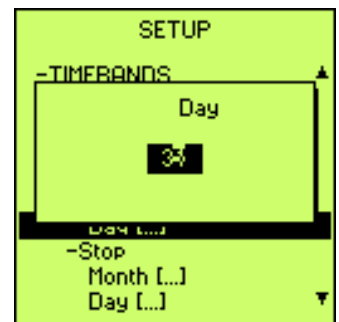
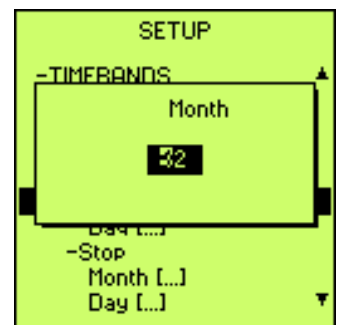
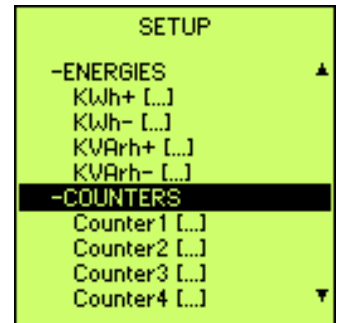
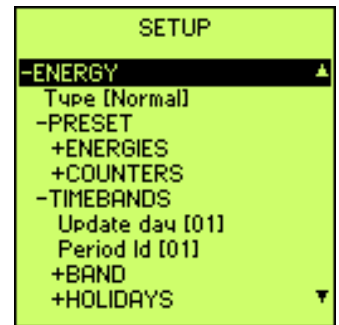

WeekDay, defines the days of the week in the selected period in which the tariff programming is active.
Use the “LEFT” and “RIGHT” keys to select the day of the week and the “UP” and “DOWN” keys to enable or disable the day.

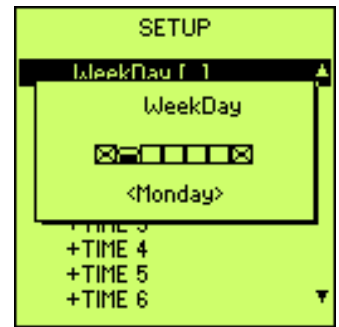

Time (1 - 12), defines the time of the day in which the energy counters are subdivided in the 4 time bands P1, P2, P3, P4, to set the time bands are available 12 different times.

Inside the **Time** it's possible to set the hour (**StartHour**) and the minutes (**StartMin.**) in which the time band starts. Select **Type**, insert the band P1, P2, P3 or P4 to link at the consumptions.

The set band will finish when another band will start or at the end of the day. For example if the energy consumption from 8.00 to 12.00 are in the band P2 and from 12.00 to 18.00 in the band P3 it's necessary to set 8.00 like start time (StartHour and StartMin) in TIME 1 with band P2 (Type), 12.00 like start time (StartHour and StartMin) in TIME 2 with band P3 (Type) and 18.00 like start time (StartHour and StartMin) in TIME 3 with band P1 (Type); in this way the P1 band will maintain until 8.00 of the day after without other programming. P1 band is the most economic and the P4 band is the most expensive.

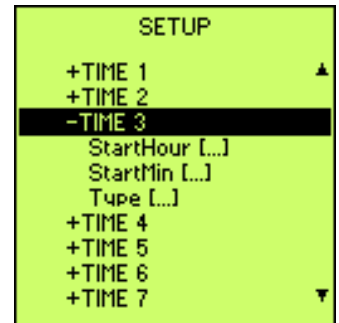

• **HOLIDAYS**

It's possible to program the days in the year in which the time bands programmed are not used and the energy consumption end up in the economic band (P1). This function can be useful in holiday or in days in which the energy suppliers apply different tariff of others days.

It's possible to program:

- **Day Index**, allows to set 52 different days like holidays. After the index, define the day of the year.
- **Month**, is the month of the day in programming. One number from 1 to 12 defines the month (1 January, 2 February, etc.)
- **Day**, is the day of the month corresponding at the holyday: from 1 to 31.

Example:

New year's day 1 January
Day index = 1
Month = 01 (January)
Day = 01

Christmas 25 December:
Day index = 2
Month = 12 (December)
Day = 25

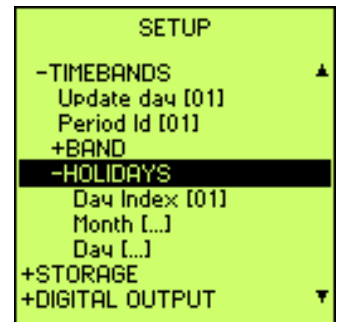

The consumption of this special feature, if used, will be saved, always, into the tariff P1.

11.7) STORAGE

The STORAGE menu allows the programming of the data to store. 4 section of storing exist:

- relative minimums and maximums
- average powers
- harmonic components
- samples (only with NRG software or serial command)

The storage is organized as FIFO (first in first out) type memory. When the memory is full older data will be overwritten by new data.

• MIN & MAX

The acquisition time is expressed in minutes, up to 12 MIN & MAX values are stored.

Enable, confirming the “ENABLE” voice the operator may enable (ON) or disable (OFF) the acquisition of MIN & MAX values.

Measures, parameters to store.

Select the variable to store in the minimums and maximums with the “LEFT” and RIGHT” keys, enable or disable this variable with “UP” and “DOWN” keys.

Rate – min., acquisition time.

This is the acquisition time of minimum and maximum values: range 1 ÷ 9999 minutes. For example to store the minimum and the maximum value of programmed parameters each 15 minutes it’s necessary to set 15.

If the storing of minimum and maximum values is enabled the values shows in the relative page are updated at the same acquisition time set for the storing in memory. Minimum and maximum values are not absolute any more.

• Average Power

Storing of average active and reactive power. It’s possible to enable or disable the storing. The sampling time is set at 15 minutes but it’s modifiable (Time Avg).

• Harmonics

Up to the 31st harmonics are stored for each line both of voltage and current channels.

Enable, the operator may enable or disable the storing of harmonic values.

The sampling time is fixed at 15 minutes and it’s not modifiable.

If any of the above mentioned parameters has been enabled for storage, by exiting the setup menu a brief message will appear, asking the operator to erase all the previous stored data, in the memory, in order to enable a new recording campaign at empty memory with no residual information’s.

The data downloaded on PC using NRG software or communication protocol does not come deleted and for this reason it’s possible to recover them using the function of communication protocol.

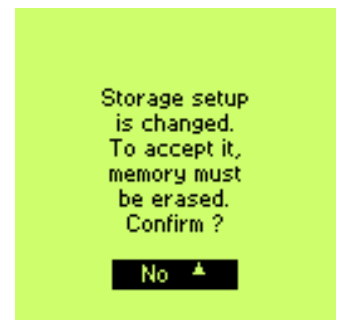
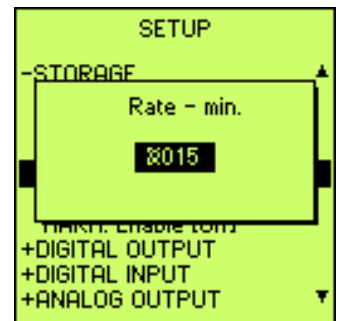
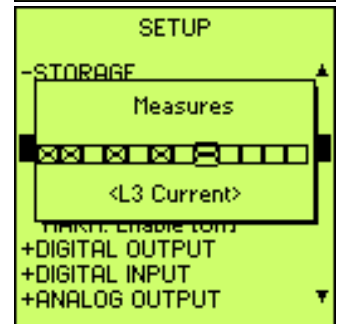
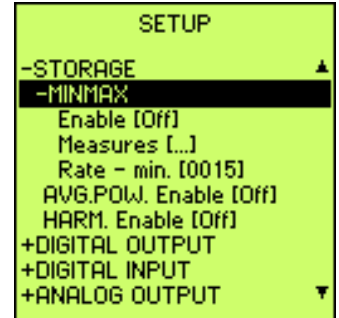

11.8) DIGITAL OUTPUT

The digital outputs can be programmed to function like alarm (overload, load management for consumption optimization, etc.), or pulses emission for energy calculation or remote activation using software NRG.

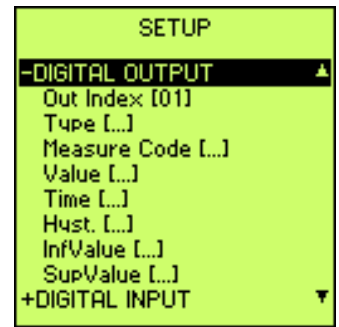

- **Out Index**, expresses the number of output, from 1 to 6 (DO1 and DO2 standard), to select or program, which are present on the hardware of the instrument.
- **Type**, allows to select the type of functioning as:
 - Always Off: digital output is always disabled.
 - Energy Pulse: pulse emission proportional at energy registered and depending the programming used (valid only for Energies).
 - Min. Threshold: the output is enabled if the value of the selected variable is lower of the programmed value.
 - Max. Threshold: the output is enabled if the value of the selected variable is higher of the programmed value.
 - Band: the output is enabled if the value of the selected variable is lower of the programmed minimum value or higher of the programmed maximum value.
 - Always On: digital output is always enabled.
- **Measure Code**, is the measure (see cap. 12) to associate at the digital output. To program the digital output as pulse emission it's necessary to select an energy variable.
- **Value**, intervention threshold value (i.e., for overcoming 340V program 340.0, or 150kW program 150000,0) or pulse weight (i.e., if the active positive energy pulses must be emitted every 1 kWh program 1.00) programmable from 0,01 to 100 kWh/pulse.
- **Time**, is the threshold delay for intervention expressed in second (0-655 seconds) or duration time of Pulse expressed in milliseconds (50-500 ms).
- **Hysteresis**, it's the percentage of alarm's value under which the alarm come back in off condition: it's programmable from 0 to 99% (example: max threshold of active power at 150kW with 10% hysteresis means the alarm come back in off condition when the active power will be 150-15=135kW). It's not available in Pulse mode.
- **InfValue** and **SupValue**, low limit and high limit of alarm in band way.

Note: digital output management for P.F.-cosΦ.

In the P.F. and cosΦ the absolute minimum is considered the 0 capacitive and the absolute maximum the 0 inductive.

To set an alarm when the cosΦ is less than e.g. 0.9 inductive (in the direction of 0 inductive) it's necessary to set MAX threshold mode. Instead of this, to set an alarm when cosΦ is more than e.g. 0.9 inductive (in the direction of 0 capacitive) it's necessary to set MIN threshold mode. In BAND mode there will be alarm when the cosΦ value will be extern to the set band (infvalue÷supvalue): the infvalue must be the value nearest at the 0 capacitive.

Example:

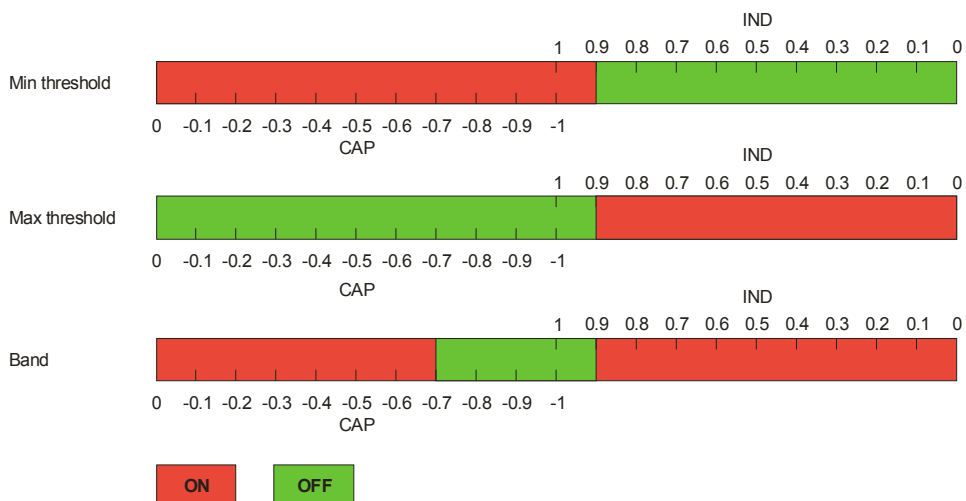

11.9) DIGITAL INPUT

In the DIGITAL INPUT menu it's possible to program the digital input function for both standards and options. The 2 standards digital input can be programmed how follow:

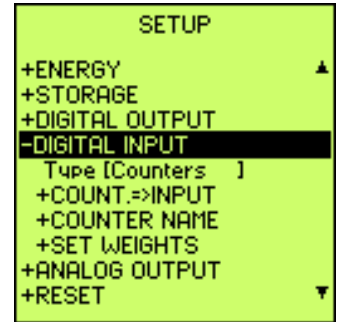

- **Type**, defines the type of operation:

- NOT USED: if none input is selected or enabled.
- CLOCK SYNCRONIZATION: Synchronization of the internal clock. When the impulse arrives on digital input, the internal clock's seconds counter is cleared if it's between 00 and 29, while if it's between 30 and 59, it's cleared and the minutes counter go on the next minute.

Example:

17:31:23 (hh:mm:ss) will be 17:31:00

08:45:55 (hh:mm:ss) will be 08:46:00

- PERIOD: to change the bands for the energy counter with time bands.

The following table shows the time band selected depending of the status of digital inputs:

DIGITAL INPUT 2	DIGITAL INPUT 1	BAND SELECTED
OPEN	OPEN	P1
OPEN	CLOSED	P2
CLOSED	OPEN	P3
CLOSED	CLOSED	P4

CLOSED: there is a voltage from 12Vcc and 24Vcc.

OPEN: the voltage is 0Vcc.

The change of band happens when the instrument recognizes a change of status on one of digital input at least.

At the moment of the digital inputs enabling like "Periods" and at the EMA's turn on with the enabling already set, the energy counters increment continue on the last band enabled independently of the digital inputs status until the change of the minute of the internal clock or the change of the status of one of digital input.

- COUNTERS: the generic counters are enabled. When an input receives a pulse, the counter, joined at this input, is increased by the value that depends of the weight set.
- Ext.DI: the function depends of the Sync. Avg set in the menu AVERAGE (par. 11.5). If Sync. Avg is Int.Rtc a signal (12÷24Vcc) on the digital input 1 change the band (from P1 to P2 and vice versa) while a signal (12÷24Vcc) on the digital input 2 is used to synchronize the average and the average powers storing (if enabled) with a de-bounce time of 30 seconds. The digital inputs are set automatically to Ext.DI if the Sync. Avg is set to Ext.DI or Int+Ext.

No congruent operation of digital input type and Sync. Avg will involve the visualization of the warning message on the display (see for example in this figure).



An item selected in the menu "TYPE" of the digital inputs will be accepted only if the reset of the counters is confirmed.

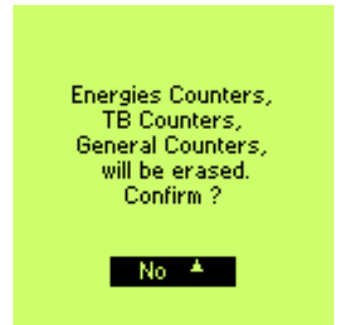

- **Count. => Input**, define the correspondence between the index of the counter and the digital input. It's necessary to set the index of the digital input to join at each counter used. The counter isn't able to count if the index inserted is 0.

Note: It's possible to join the same input at more counters.

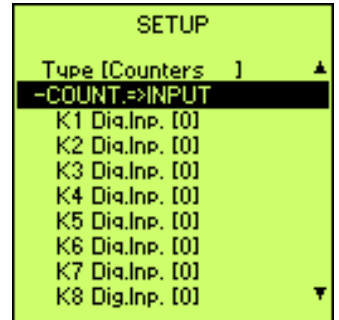

- **Counter Name**, allows to define the name for each counters. Using the "up" and "down" keys it's possible to choose the counter that will be selected with the "Enter" key. In the same way it's possible to choose and set the name of the counter. The first item allows to set a user definition, the others are names already fixed.

- USER DEF. The name of the counter is defined by the user.
When this item is selected, a field appear to input the name of the counter. To input the name it's necessary to use the "right" and "left" keys to select the type to modify, while it's possible to use "up" and "down" keys to change it.

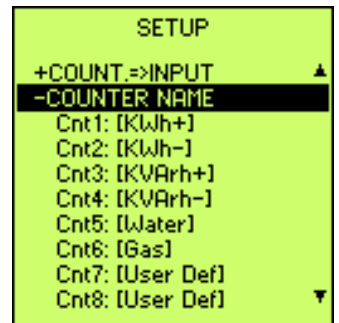

Pressing the "up" key, the sequence of the type is the following:

A B C D E F G H I J K L M N O P Q R S T U V W X Y Z a b c d e f g h i j k l m n o p q r s t u v w x y z "SPACE" 0 1 2 3 4 5 6 7 8 9; then the sequence begin from A again. Naturally, pressing the "down" key the sliding happen on the contrary.

- kWh+
- kWh-
- kVArh+
- kVArh-
- Water
- Gas

- **Set Weights**, allows to set, for each counter, the weight of the pulse. The value set is the number of pulse for unit of increase of the counter (ex. to see to increase the counter of one unit each 5 pulse, it's necessary to set the value 5).

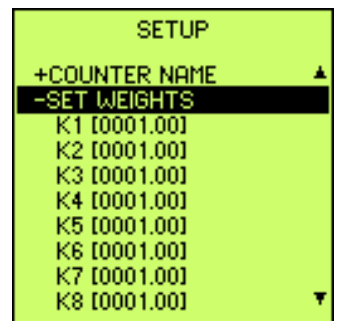

11.10) ANALOG OUTPUT (OPTION)

Selecting the analog output voice, the following programming page appears:

- **Out Index**, expresses the number of output to select or program, which are present on the hardware of the instrument.

- **Type**, allows to select the value of current output, (disabled, 0-20mA, 4-20mA).
Through the up & down keys, it may be possible to select the type of the output current, by pressing the “ENTER” key the configuration is saved.

- **Measure Code**, is the measure (see cap. 12) to associate at the analog output.

- **Min.**, full-scale value of the lower limit of the programmed value (Measure Code).
Once the minimum full-scale has been programmed, the instrument automatically will associate the minimum current value (0 or 4 mA) at this value.

- **Max.**, full-scale value of the upper limit of the programmed value (Measure Code).
Once the maximum full-scale has been programmed, the instrument automatically will associate the maximum current value (20 mA) at this value.

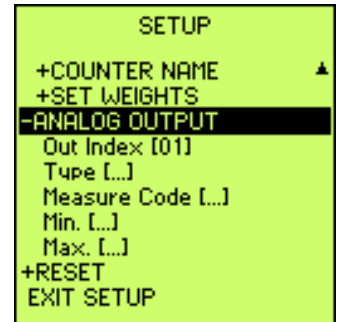

If the minimum end-scale value is lower of maximum end-scale value, the out of current will be directly proportional at variable set, otherwise it will be inversely proportional. Minimum and maximum can be negative value.

11.11) RESET

The Reset page allows to cancel some operation or the complete operation of the setup system, reset modes are classified in four groups.

RESET MEASURES, reset all values or selected group of measure. In particular:

- **All**, reset all of measures (minimum and maximum, energy counter, time bands).
- **Energies**, reset total energy counters.
- **TimeBands**, reset time bands.
- **Min/Max**, reset minimums and maximums.

Reset Setup, delete all definition in the setup and the instrument come back to default setup.

Reset Storage, delete all data stored in the memory.

Reset Counter, delete all counters joined at digital inputs.

Reset Max.Demand, delete max demand values.

Reset Global, reset complete of the instrument (Setup, measures stored, RAM).

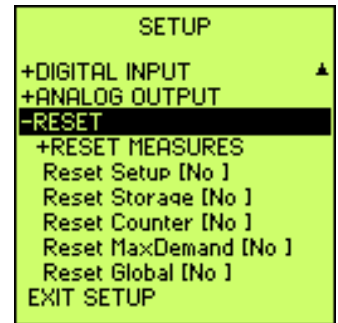
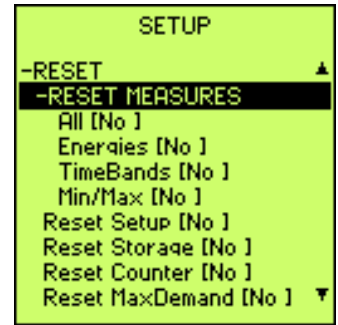

11.12) EXIT SETUP

The last voice of the setup menu is “EXIT SETUP”, which allows the operator to leave the instrument setup and go back to the “REAL TIME VISUALIZATION PAGES”.

Operator may also exit the setup by pressing simultaneously the “RIGHT & LEFT” button one or more time depending of the branch in which you are.

12) LIST OF MEASURES

To program the variables in setup for:

- digital outputs (alarm and pulse)
- analog outputs

it's necessary to use these codes:

3Ph.V	Three-phase voltage
L1N V	L1 phase voltage
L2N V	L2 phase voltage
L3N V	L3 phase voltage
L12 V	Voltage between L1 and L2 phases
L23 V	Voltage between L2 and L3 phases
L31 V	Voltage between L3 and L1 phases
3Ph.I	Three-phase current
L1 I	L1 phase current
L2 I	L2 phase current
L3 I	L3 phase current
THDI L1	THD current L1 phase
THDI L2	THD current L2 phase
THDI L3	THD current L3 phase
3Ph.PF	Three-phase power factor
L1 PF	L1 phase power factor
L2 PF	L2 phase power factor
L3 PF	L3 phase power factor

3 Ph.Cos	Three-phase Cos Φ
L1 Cos	L1 phase Cos Φ
L2 Cos	L2 phase Cos Φ
L3 Cos	L3 phase Cos Φ
3Ph.VA	Three-phase apparent power
L1 VA	L1 phase apparent power
L2 VA	L2 phase apparent power
L3 VA	L3 phase apparent power
3Ph.W	Three-phase active power
L1 W	L1 phase active power
L2 W	L2 phase active power
L3 W	L3 phase active power
3Ph.VAr	Three-phase reactive power
L1 VAr	L1 phase reactive power
L2 VAr	L2 phase reactive power
L3 VAr	L3 phase reactive power
3Ph.Wh+	Three-phase positive active energy
3Ph.VArh+	Three-phase inductive reactive energy
3Ph.Wh-	Three-phase negative active energy
3Ph.Varh-	Three-phase capacitive reactive energy
THDV L1	THD voltage L1 phase
THDV L2	THD voltage L2 phase
THDV L3	THD voltage L3 phase
Avg.W	Average three-phase active power
Avg.I	Average three-phase current
Avg.Var	Average three-phase reactive power
Temp.	Temperature
L1Avg.I	Average current L1 phase
L2Avg.I	Average current L2 phase
L3Avg.I	Average current L3 phase
Neutr.I	Neutral current
Vunb	Voltage unbalance
Iunb	Current unbalance
KFact1	L1 phase K factor
KFact2	L2 phase K factor
KFact3	L3 phase K factor

13) PROBLEMS AND SOLUTIONS

If you have a problem setting up or using your instrument, you may be able to solve it yourself. Before calling your retailer or nearest distributor you should try the suggested actions that are appropriate to your problem.

Problem	Possible cause	Suggested
The instrument doesn't turn on.	<ul style="list-style-type: none"> - The power supply is disconnected or wrong. - The internal fuse is interrupted. 	<ul style="list-style-type: none"> - Verify the connection and the presence of power supply. - See the chap. cap. 6.1) to verify and/or to change the internal fuse.
The display is completely dark or clear.	<ul style="list-style-type: none"> - Contrast badly adjusted 	<ul style="list-style-type: none"> - Adjust contrast as described on 9.1).
The instrument doesn't communicate with the NRG software (or other communication software).	<ul style="list-style-type: none"> - Communication wires. - Communication protocol. - Wiring system and communication parameters. 	<ul style="list-style-type: none"> - Verify the correct wiring. - Verify that the communication protocol of the instrument coincides with the one used in the sw. - Verify the wiring type (RS232 or RS485) and the settings of the serial port of the instrument.
The instrument communicates with the PC but the communication is interrupted.	<ul style="list-style-type: none"> - Not shielded wires. - Lack of terminations. 	<ul style="list-style-type: none"> - Use shielded wires. - Connect terminations as par. 8.4.1) and 8.4.2).
The instrument has lost the CODE or the PASSWORD.	<ul style="list-style-type: none"> - E²prom lost data. 	<ul style="list-style-type: none"> - to try again to input another time the data lost.

If the problem has not been solved, or for other information's not covered in the present manual, please contact with our Technical Assistance Department.

Before contacting, it is suggested to collect the maximum information regarding the installation, and mainly the following data:

1. Model and serial number from the label on the top of the instrument housing.
2. Purchase receipt.
3. Description of problem.
4. System configuration (hardware fitted, firmware release etc.).

14) EMA SERIAL COMMUNICATION PROTOCOL

The Electrical Multifunction Analyzer EMA series are disposal with two communication standard protocols:

- ASCII
- MODBUS-RTU

and optional

- PROFIBUS with external module
- TCP/IP Ethernet with external module

The standard communication protocol has been optimised for the connection of the analysers with the NRG management software, allowing to use all the available functions (automatically search of the unit in the network, automatic data downloading, etc.).

Even so the NRG software supports the MODBUS protocol.

About all the information of protocols communication to see specific user manual (EMA SERIAL COMMUNICATION PROTOCOL).

15) Notes

WARNING: Megacon declines all liability for any damage to people or property caused by improper or incorrect use of its products.

Megacon reserves the right to change product specifications without prior notice.

